



Smart Temp TST

## Smart Temp TST

### Electronic thermostat + temperature transmitter

Smart Temp electronic thermostats are used wherever it is necessary to carry out special monitoring tasks combined with switching functions. The device is ideal for two-stage temperature control. Smart Temp is therefore highly suitable for temperature control in mechanical and plant engineering, fluidics, process engineering and pneumatics, and for monitoring and control of heating systems, climatic cabinets, ovens, and cooking systems.

Its open-ended sensor technology means that the range of possible applications is growing all the time. In the TST...-R version, floating switching signals are output via a relay contact. A convenient and configurable analog output transmits critical process temperatures to measurement and control systems.

#### Technical data

<b>Measuring ranges</b>	-50°C...+400°C
<b>Ambient temperature</b>	-20°C...+60°C
<b>Storage temperature</b>	-35°C...+80°C
<b>Relative humidity</b>	0...95%
<b>Overall accuracy</b>	non-condensing
<b>Weight</b>	0.5% of full scale
<b>Parts in contact with medium</b>	depends on model
<b>Process connections</b>	Built-on sensors: 1.4571, external sensors: depends on model
<b>Electrical connections</b>	Standard built-on sensor: G 1/2" external thread External sensor connection: M8 plug according to DIN IEC 60947-5-2 TS and TST versions: 5-pin M 12 plug as per DIN IEC 60947-5-2 (as accessory) TST...-R versions: Additional 3-pin M12 plug, as per DIN EN 50044 (as accessory)
<b>Sensor element</b>	PT 1000 Class A
<b>Protection class</b>	II as per EN 60335-1
<b>Climate class</b>	IP65 as per EN 60529
<b>Power supply</b>	C as per DIN EN 60654
<b>Outputs</b>	14...36 VDC 2 open-collector outputs 250 mA at 16...36 VDC Configurable as high-side/low-side switching and as push/pull outputs Switching differential (SP and RP) selectable via software
<b>Relay outputs (TST...-R)</b>	Permissible resistive load: 250 VAC, 5 A Permissible inductive load: 250 VAC, 0.8 A (200 VA) Contact type: 1 changeover contact (1 xU M) Maximum service life: 100,000 switching cycles
<b>Warning output</b>	Output configuration: Warning output on plug 2 max. 20 mA, 14...36 VDC
<b>Transmitter output</b>	Output configuration: Voltage/current 0 -10 V and 4...20 mA, configurable in expert mode
<b>Housing and cover</b>	Polybutylene terephthalate PBT-GF30, resistant to chemicals and stress cracking
<b>Display screen cover</b>	Polycarbonate PC

**i** With an **overall accuracy of 0.5%** of full scale, these electronic thermostats are also suitable for monitoring measurements in laboratory applications. Models with built-on sensors for a temperature range of **-50°C...+200°C** and models with external sensors for a temperature range of **-50°C...+400°C** are available.

Please let us know if you have special sensor requirements. We have the facilities to make your special sensor for you.

#### Functions

##### The 2 switching outputs can be configured as:

- Minimum thermostat, maximum thermostat, temperature window monitoring
- Configurable as normally closed or normally open, high-side or low-side switching and as a push/pull output
- Relay output assigned to channel 1 or 2 or to the warning output (in the case of TST...-R)

##### Configuration of the analog output:

- 0-10 V, 4-20 mA or 10-0 V and 20-4 mA
- Analog measuring range can be limited to a minimum of 50 % of the total measuring range
- Choice of temperature unit (°C and °F)

##### Smart Temp display functions:

- 4-digit digital display with bar graph for temperature, settings and set parameters
- 2 three-colour LEDs to show the switching state of the outputs, implausible settings and as a warning status indicator

#### Electrical connection:

- Two 5-pin M12 plug connections for power supply, switching outputs and analog output
- One 3-pin M12 plug connection for the relay output
- One 4-pin M8 plug connection for PT1000 Class A sensors (for all TST... EPT series)

#### Plus (Advantage):

- Switch on/off delay of 0-60 sec.
- Temperature simulation mode, two-stage locking code, restore function
- Warning function for implausible switching points, sensor fault, overload and overheating

Electronic thermostats

Type	Temperature range	Sensor immersion depth (mm)	Sensor design	Type
TST050G12100	-50 °C...+50 °C	100	Built-on	TST050G12100-R
TST050G12250	-50 °C...+50 °C	250	Built-on	TST050G12250-R
TST200G12100	-50 °C...+200 °C	100	Built-on neck-tube	TST200G12100-R
TST200G12250	-50 °C...+200 °C	250	Built-on neck-tube	TST200G12250-R
TST200EPT1K*	-50 °C...+200 °C	n.a.	External with cable	TST200EPT1K-R*
TST400EPT1K*	-50 °C...+400 °C	n.a.	External with cable	TST400EPT1K-R*

\* Wall-mounting kit for evaluation unit AST1 included.

External sensors

Type	Temperature range	Sensor immersion depth (mm)	Cable length	Comment
P2-TVS12-400100	-50 °C...+400 °C	100	2,5 m	ST8-3 plug enclosed
P2-TVS12-400250	-50 °C...+400 °C	250	2,5 m	ST8-3 plug enclosed

**+** For more stainless steel sensors, see page 129.

**+** Accessories (order separately)

Cable socket

Type

For output 1+2

ST12-5-A	5-pin	A-coded	Right-angle version
----------	-------	---------	---------------------

For output 3 (relay output)

ST12-4-A	4-pin	B-coded	Right-angle version
ST12-4-AK	4-pin	B-coded	Right-angle version with 2 m cable
ST12-4-GK	4-pin	B-coded	Straight version with 2 m cable

Cover Cap

STA12	IP 65
-------	-------

Contacting

ST12-4-AK and ST12-4-GK

Relais contact	colour	Contact
1	brown	common
2	white	NC
3	blue	NO
4	green/yellow	n.a.

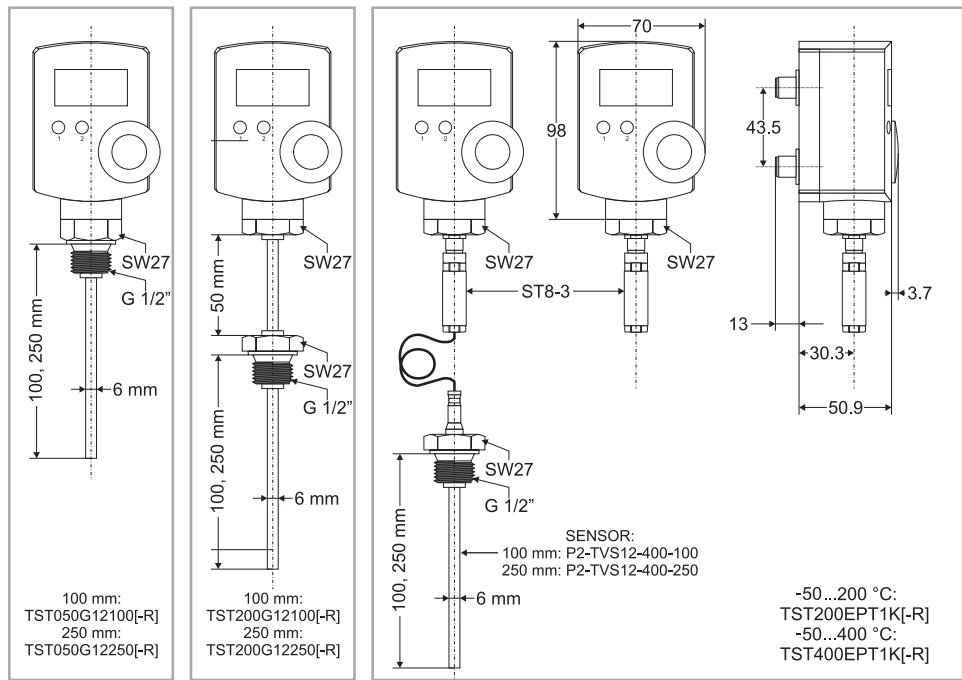

Immersion wells for Smart Temp

Types	Immersed Material length (mm)	Process connection	Comment	Max. perm. pressure
<b>G12-100</b>	100	1.4571/316L	<b>G1/2" A</b> Cyl. ext. thread	100
<b>G12-250</b>	250	1.4571/316L	<b>G1/2" A</b> Cyl. ext. thread	100
<b>R12-100</b>	100	1.4571/316L	<b>R1/2"</b> Con. ext. thread	100
<b>R12-250</b>	250	1.4571/316L	<b>R1/2"</b> Con. ext. thread	100
<b>N12-100</b>	100	1.4571/316L	<b>N1/2"</b> Con. ext. NPT thread	100
<b>N12-250</b>	250	1.4571/316L	<b>N1/2"</b> Con. ext. NPT thread	100

Mounting dimensions for Smart Temp

- Wrench size: AF 27
- Internal thread for insertion sensor: G1/2"
- Immersion tube diameter: 8 x 0.7 mm

Type	A	B	C	D	E	F
G12-100	105	36	19	14	15	83
G12-250	255	36	19	14	15	233
R12-100	105	36	19	14	15	83
R12-250	255	36	19	14	15	233
N12-100	105	36	19	14	15	83
N12-250	255	36	19	14	15	233

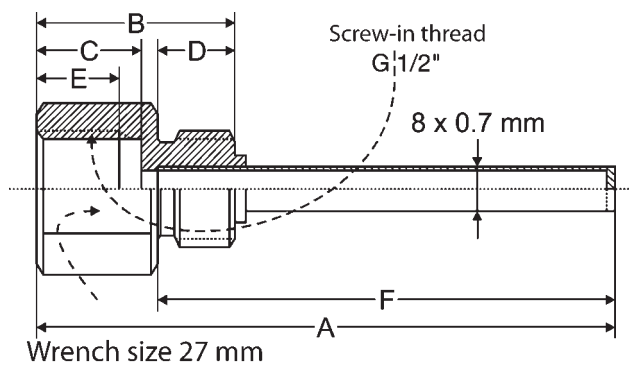

## Electrical connection

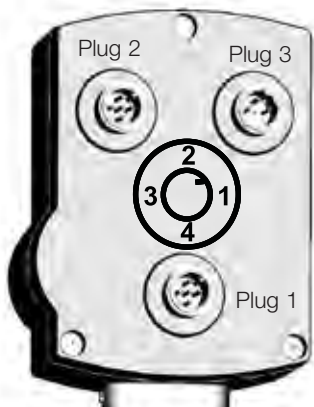

### Electrical connection and contact assignment

Electrical connection is via M12 plugs on the back of the unit. Depending on the version, either 2 (TST) or 3 (TST...-R) M12 connector plugs are available (not supplied with the unit).

#### Contact assignment on plug 1 (A-coded)

Pin 1: Supply voltage 14...36 VDC  
 Pin 2: OUT 2 (output 2) open collector output  
 Pin 3: 0 volt (earth)  
 Pin 4: OUT 1 (output 1) open collector output  
 Pin 5: Serial interface (locked for calibration)

#### Special characteristic of open collector outputs

Depending on the design, the output voltage at open collector outputs can be up to 2.5 V lower than the applied supply voltage.

Example: Supply voltage 14 V... Output voltage OUT 1 approx. 11.5 V.

#### Contact assignment on plug 2 (A-coded)

All versions of series TST and TST...-R are also equipped with an A-coded M 12 plug.

Pin 1: Supply voltage 14...36 VDC  
 Pin 2: WARN (warning output max. 20 mA)  
 Pin 3: 0 V (earth)  
 Pin 4: Analogue output AOUT  
 Pin 5: Serial interface (locked for calibration)

Units of the TST series can be powered both via plug 1 and via plug 2. If the TST is used purely as a transmitter, only one connection via plug 2 is needed, because the supply voltage can be connected here too (see "Contact assignment on plug 1").

#### Contact assignment on plug 3 (B-coded)

All versions of series TST...-R are also equipped with a B-coded M 12 plug.

Pin 1: Common contact  
 Pin 2: Normally closed contact  
 Pin 3: Normally open contact

## Switch outputs

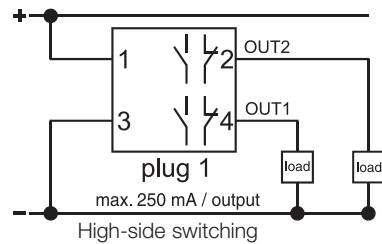
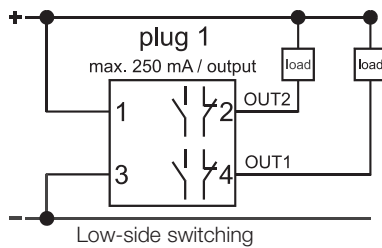

### Switch output OUT1 and OUT2

The switch outputs can be configured via the software (at expert level) both as normally closed / normally open, and as high-side and low-side switching.

In **normally closed configuration**, the selected voltage potential (earth or supply voltage) occurs at the output in the **unswitched** state.

In **normally open configuration**, the selected voltage potential (earth or supply voltage) occurs at the output in the **switched** state.

In the **low-side switching configuration**, the outputs switch the voltage potential 0V (earth) with respect to a consumer connected to OUT1 or OUT2.

In the **high-side switching configuration**, the outputs switch the supply voltage potential (minus approx. 2V) with respect to a consumer connected to OUT1 or OUT2.

**If the power supplies of the pressure switch and connected load are independent of one another, the following must be taken into account: The potential difference between OC output and earth and OC output and supply voltage must not exceed 36 VDC. If the configuration is "low-side switching", the external power supply must have the same earth reference as the device itself. If the device is defined as "high-side switching", the external power supply must be connected to the positive power supply of the device. It is important to note that the voltage drop in the through-connected state can be as much as 2 V.**

**The maximum permitted current at the OC is 250 mA per switch output (OUT1, OUT2).**

**A maximum switching current of 250 mA may flow through each channel.**

The switching channels are short-circuit-proof and they are monitored for current and temperature.

Where current limiting is used and on overheating, both LEDs light up red (WARN function).

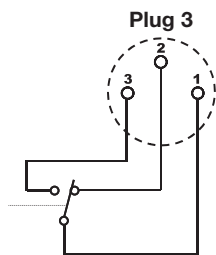

### Relay output REL

The relay output is realised in version **TST...-R**. In expert mode the analogue output can be coupled via the software with output 1 (OUT1) and output 2 (OUT2), and with the WARN function. This means that the user can choose a potential-free output for these 3 important functions. The changeover contact of the relay is designed for a maximum resistive load of 4A and an inductive load of 200VA. At the lower end the 5µ gold-plated silver contacts are designed for a minimum load of 50 mW (5 V at 10 mA).

**It should always be remembered that, after a one-off maximum load on the switching current side, the gold plating of the contacts is stripped so they can no longer be used for low-current and low-voltage applications.**

## Analogue output

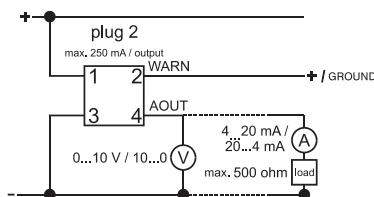

### Analogue output

The analogue output (AOUT) is available in versions TST and TST...-R. In expert mode it is configurable both as a 0-10 V/10-0 V, and as a 4-20 mA/20-4 mA output. The unit is supplied with the output configured for 0-10 V.

The input impedance of the connected consumer **must not exceed 500 ohms**.

# Temperature sensors

Accessories

Solenoid valves

Flow monitors

Temperature sensors

Thermostats

Pressure transmitters

Pressure switches

# General notes on temperature measurement

with resistance sensors Pt 100 and Pt 1000

## Connection possibilities for Pt... sensors

### Two-wire connection

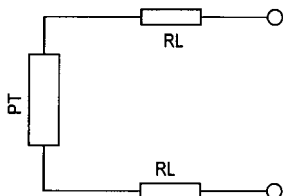

Advantage: Only 2 wires  
Disadvantage: The line resistance RL distorts the measurement result

### Three wire connection

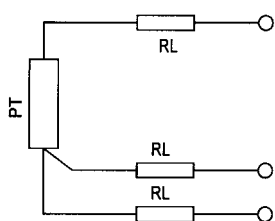

Advantage: The line resistances are taken into account by the electronic analyser. The measurement result is not distorted.  
Disadvantage: 3 wires are needed. All 3 wires must have the same resistance.

### Four-wire connection

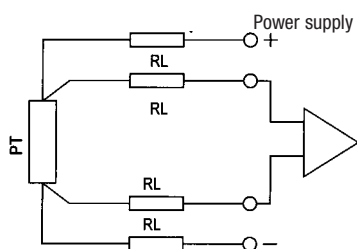

Advantage: The line resistances do not play any role due to the electronic analyser (current feed and high-ohmic voltage sensing). The measurement result is not distorted. The lines can have different resistances.  
Disadvantage: 4 wires are needed.

Connection wires with the same colours are electrically connected to one another.

Platinum temperature sensors Pt 100 or Pt 1000 make use of the constant change in resistance of materials at changing temperatures. A platinum-rhodium alloy specially suited to this purpose is normally used because of its good stability and high reproducibility. The resistance of the sensor increases as the temperature rises.

The resistance values are stipulated in DIN IEC 751 as follows:

**Pt 100 = 100 ohms at 0°C**

**Pt 1000 = 1000 ohms at 0°C**

The resistance values for all temperatures are quoted in the above-mentioned standard. The resistance sensors are divided into accuracy classes according to their limiting error.

**For FEMA Pt 100/1000 sensors, Class A applies: 0.15 K + 0.002 x t\***

\*t is the numerical value of the temperature in °C (disregarding the sign)

### Resistance values of Pt 100 sensors (except from DIN 43 760, IEC 751)

Temperature °C	Basic values of Pt 100											Temperature °C
	0	1	2	3	4	5	6	7	8	9	10	
- 50	80,31	79,91	79,51	79,11	78,72	78,32	77,92	77,52	77,13	76,73	76,33	- 50
- 40	84,27	83,88	83,48	83,08	82,69	82,29	81,89	81,50	81,10	80,70	80,31	- 40
- 30	88,22	87,83	87,43	87,04	86,64	86,25	85,85	85,46	85,06	84,67	84,27	- 30
- 20	92,16	91,77	91,37	90,98	90,59	90,19	89,80	89,40	89,01	88,62	88,22	- 20
- 10	96,09	95,69	95,30	94,91	94,52	94,12	93,73	93,34	92,95	92,55	92,16	- 10
0	100,00	99,61	99,22	98,83	98,44	98,04	97,65	97,26	96,87	96,48	96,09	0
0	100,00	100,39	100,78	101,17	101,56	101,95	102,34	102,73	103,12	103,51	103,90	0
10	103,90	104,29	104,68	105,07	105,46	105,85	106,24	106,63	107,02	107,40	107,79	10
20	107,79	108,18	108,57	108,96	109,35	109,73	110,12	110,51	110,90	111,28	111,67	20
30	111,67	112,06	112,45	112,83	113,22	113,61	113,99	114,38	114,77	115,15	115,54	30
40	115,54	115,93	116,31	116,70	117,08	117,47	117,85	118,24	118,62	119,01	119,40	40
50	119,40	119,78	120,16	120,55	120,93	121,32	121,70	122,09	122,47	122,86	123,24	50
60	123,24	123,62	124,01	124,39	124,77	125,16	125,54	125,92	126,31	126,69	127,07	60
70	127,07	127,45	127,84	128,22	128,60	128,98	129,37	129,75	130,13	130,51	130,89	70
80	130,89	131,27	131,66	132,04	132,42	132,80	133,18	133,56	133,94	134,32	134,70	80
90	134,70	135,08	135,46	135,84	136,22	136,60	136,98	137,36	137,74	138,12	138,50	90
100	138,50	138,88	139,26	139,64	140,02	140,39	140,77	141,15	141,53	141,91	142,29	100
110	142,29	142,66	143,04	143,42	143,80	144,17	144,55	144,93	145,31	145,68	146,06	110
120	146,06	146,44	146,81	147,19	147,57	147,94	148,32	148,70	149,07	149,45	149,82	120
130	149,82	150,20	150,57	150,95	151,33	151,70	152,08	152,45	152,83	153,20	153,58	130
140	153,58	153,95	154,32	154,70	155,07	155,45	155,82	156,19	156,57	156,94	157,31	140
150	157,31	157,69	158,06	158,43	158,81	159,18	159,55	159,93	160,30	160,67	161,04	150
160	161,04	161,42	161,79	162,16	162,53	162,90	163,27	163,65	164,02	164,39	164,76	160
170	164,76	165,13	165,50	165,87	166,24	166,61	166,98	167,35	167,72	168,09	168,46	170
180	168,46	168,83	169,20	169,57	169,94	170,31	170,68	171,05	171,42	171,79	172,16	180
190	172,16	172,53	172,90	173,26	173,63	174,00	174,37	174,74	175,10	175,47	175,84	190
200	175,84	176,21	176,57	176,94	177,31	177,68	178,04	178,41	178,78	179,14	179,51	200

The resistance values of Pt 1000 are higher by a factor of ten.

When Pt sensors are connected, the line resistances between the measuring point and evaluation unit (e.g. transmitter) must be taken into account (see left column).

All FEMA evaluation units (transmitters and temperature switches) have an input circuit for 3-wire connection. The sensors must be connected as shown in the following diagrams. All three wires must be of equal length and have the same conductor cross-section to compensate for the line resistances.

### Two-wire sensor

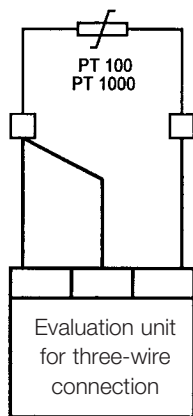

### Three-wire sensor

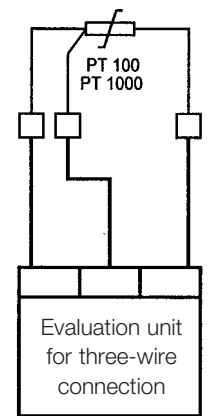

### Four-wire sensor

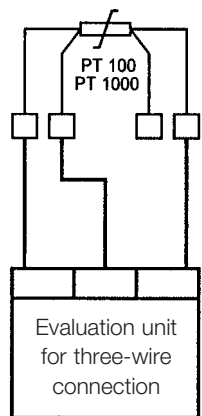



P100

## P

### Pt 100 temperature sensors in stainless steel

The temperature sensors are made entirely from stainless steel 1.4571. Sensor element: Pt 100, Class A to DIN IEC 751, 3-wire connection. Cable entry M16x1.5, Protection class IP 67. Temperature range -50...+400 °C.

#### Technical Data

Housing and cover	Stainless steel 1.4571/316Ti
Parts in contact with medium	Stainless steel 1.4571/316Ti
Temperature of medium	-50...+400 °C
Process connection	G1/2" Außengewinde
<b>Electrical connection</b>	
P100...	screw clamp on ceramic base
Cable entry	M 16 x 1,5 screw clamp
Cable diameter	ø 6–9 mm
Protection rating	IP 67 (when connected properly)
Max. permissible pressure	100 bar
Response time	$\tau_{0.9} = 12 \text{ sec}$ (in water at 0,4 m/s)

#### Immersion sensors with screw-in thread G1/2", 6 mm ø

Type	Max. permissible pressure (bar)	Immersion depth L (mm)
<b>P100-100</b>	100	100
<b>P100-150</b>	100	150
<b>P100-200</b>	100	200
<b>P100-250</b>	100	250

#### Immersion wells (screw-in thread G1/2")

Type	Immersion depth	Thread	Max. permissible pressure (bar)
<b>G12-100</b>	100	G1/2"	100
<b>G12-150</b>	150	G1/2"	100
<b>G12-200</b>	200	G1/2"	100
<b>G12-250</b>	250	G1/2"	100
<b>R12-100</b>	100	R1/2"	100
<b>R12-150</b>	150	R1/2"	100
<b>R12-200</b>	200	R1/2"	100
<b>R12-250</b>	250	R1/2"	100
<b>N12-100</b>	100	1/2" NPT	100
<b>N12-150</b>	150	1/2" NPT	100
<b>N12-200</b>	200	1/2" NPT	100
<b>N12-250</b>	250	1/2" NPT	100

#### Dimensioned drawing (mm)

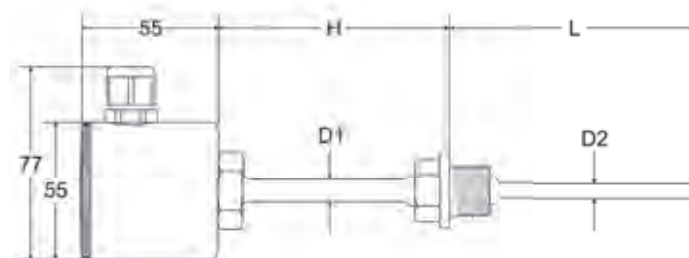

L (Fitting length)	D1 (Protection tube ø)	D2 (Protection tube ø)	H (Protection tube ø)
100 mm	9 mm	6 mm	70 mm
150 mm	9 mm	6 mm	70 mm
200 mm	9 mm	6 mm	70 mm
250 mm	9 mm	6 mm	70 mm





Strap-on sensor ALF21/31

## High-quality sensors for HVAC and industrial applications ALF..., TF..., KF..., RF21/31

Accurate Pt 100 / Pt 1000 Class A sensors with IP 65 plastic terminal box

The highly accurate and reliable sensors of the ALF, TF, KF and RF series are designed for demanding HVAC applications. They are also suitable for industrial applications, where 3-wire

technology is standard and IP 65 protection is considered necessary for the terminal box. A very low-cost yet highly accurate solution thanks to the use of Pt 100/1000 Class A sensors.

### Technical data

#### Sensor accuracy

Sensor technology IEC751 Class A  
0.15 K + 0.2 % • [t]  
(t in °C)

#### Sensitivity

Pt 100 ≈ 0.385 Ω / K  
Pt 1000 ≈ 3.85 Ω / K

#### Electrical connection

Cable connection PG11 and screw terminals 3 x 1.5 mm<sup>2</sup>

#### Electrical data

Measuring current 1 mA  
Insulation resistance > = 100 MΩhm at 20 °C (500VDC)

Sensor connection 3-wire  
Protection class IP 65

The ALF series strap-on sensors have a spring-loaded sensor ensuring good heat transfer at all times. In view of the 3-wire design, these sensors (Pt 1000A version) are recommended as an economical alternative for use together with TST...EPT1K.

### Types, applications and materials

Type	Description	Max. perm. pressure immersion tube	Temperature range	Sensor	Protective tube material
ALF21	Strap-on sensor	n.a.	-30 bis +110 °C	Pt 100	n.a.
ALF31	Strap-on sensor	n.a.	-30 bis +110 °C	Pt 1000	n.a.
TF21*	Immersion sensor 40 bar		-30 bis +150 °C	Pt 100	1.4301
TF31*	Immersion sensor 40 bar		-30 bis +150 °C	Pt 1000	1.4301
KF21**	Air duct sensor	n.a.	-30 bis +150 °C	Pt 100	1.4301
KF31**	Air duct sensor	n.a.	-30 bis +150 °C	Pt 1000	1.4301
RF21	Room sensor	n.a.	-50 bis +90 °C	Pt 100	1.4571
RF31	Room sensor	n.a.	-50 bis +90 °C	Pt 1000	1.4571
ST8-3	Sensor plug for attachment to TST...EPT1K				

\* A thermowell made from 1.4571 stainless steel is included.

\*\* A PVC mounting flange is included.

Terminal box made from PA6 (polyamide)

### Dimensioned drawings (mm)

#### TF/KF21/31

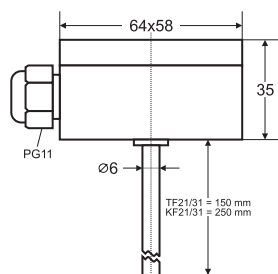

#### RF21/31

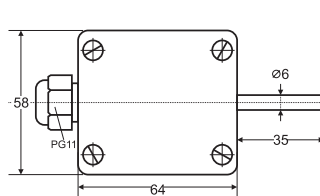

#### ALF21/31

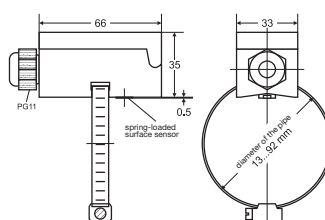

#### Attached accessory TF/KF21/31

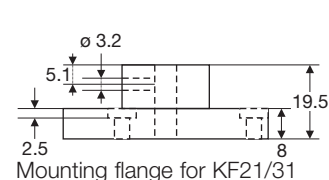

Mounting flange for KF21/31

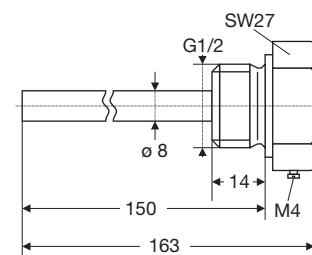

Thermowell for TF21/31

Strap for pipe dia. 13 to 92 mm included.

Air duct sensor  
KF21/31

Room temperature sensor RF21/31



## Specifications

### TRM/TRMV

Room thermostats for industrial premises, type TRM, setting range from ... to ...°C.  
Switching differential not adjustable / adjustable.  
Diecast aluminium with plug connection to DIN EN175301.

### T6120

Room thermostats for industrial rooms type T6120 ... setting range from ... till ... °C.  
Switching differential adjustable / fixed.  
Switching housing made of ABS, fibre glass armoured.

### H6045A1002

Duct hygrostat, setting range 35 ... 100% r.h.  
Switching housing made of ABS, fibre glass armoured.

### H6120A200

Duct hygrostat, setting range 35 ... 100% r.h.  
Switching housing made of ABS, fibre glass armoured.

### STW

Safety temperature switch  
Setting range from ... till ... °C, switching differential fixed.  
Approved according to PED 97/23/EC.  
Approved acc. to DIN EN14597 and therefore permitted for use in heating installations acc. to DIN EN12828.

### STB

Safety temperature limiter  
Setting range from ... till ... °C, switching differential fixed.  
Approved according to PED 97/23/EC.  
Approved acc. to DIN EN14597 and therefore permitted for use in heating installations acc. to DIN EN12828.

### FT69

Frost protection thermostat for air heating- and conditioning.  
Setting range -10°C ... +12 °C, set point at +5°C falling,  
Capillary length: ... m, reset manually / automatically,  
Switching housing: ABS and polycarbonate.

### TAM

Capillary tube thermostat type TAM... range of adjustment from ... to ...°C. Capillary tube length 1.5 m, diecast aluminium with plug connection to DIN 175301.

### TX

Rod thermometer type TX ..., range of adjustment from ... to ...°C. Immersion depth 135 mm / 220 mm, diecast aluminium housing with plug connector to DIN 175301.

### STB+TWF/STB+TRF

Safety temperature limiter and control / monitoring.  
Setting range from ... till ... °C, switching differential fixed.  
Approved according to PED 97/23/EC.  
Approved acc. to DIN EN14597 and therefore permitted for use in heating installations acc. to DIN EN12828.

## Specifications

### **TST**

Electronic thermostat and temperature transmitter with 2 open collector switching contacts and analogue output signal, power supply 14-36V DC, protection class IP65 switching points are free adjustable, setting range: ... till ... °C, immersion depth ... mm. Free programmable analogue output signal 4 ... 20mA or 0 ... 10V (also invertible).

### **TST...R**

Electronic thermostat and temperature transmitter with 2 open collector switching contacts and analogue output signal and potential free relay output. Power supply 14-36V DC, protection class IP65, switching points are free adjustable, setting range: ... till ... °C, immersion depth ... mm. Free programmable analogue output signal 4 ... 20mA or 0 ... 10V (also invertible).

### **P**

Temperature sensor Pt100, stainless steel made (1.4571). Protection class IP67, PT100, class A acc. to DIN IEC751. 3-wire connection, cable entry M16x1.5. Setting range -50 ... +400 °C, immersion depth ... mm.

### **ALF**

Strap-on temperature sensor Pt100 / 1000, class A acc. to DIN IEC751, 3-wire connection, cable entry PG11, setting range -30 ... +110 °C.

### **TF**

Immersion temperature sensor Pt100 / 1000, class A acc. to DIN IEC751, 3-wire connection, cable entry PG11, setting range -30 ... +150 °C, sensor length 150 mm.

### **KF**

Air duct temperature sensor Pt100 / 1000, class A acc. to DIN IEC751, 3-wire connection, cable entry PG11, setting range -30 ... +150 °C, sensor length 250 mm.

### **RF**

Room temperature sensor Pt100 / 1000, class A acc. to DIN IEC751, 3-wire connection, cable entry PG11, setting range -50 ... +90 °C.