



TABLE OF CONTENT

Designation code	
How to read sensor designations	3
Circuit diagrams	
Connection according to EN 60947-5-2	4
Functional description	
Operating mode of capacitive sensors	5
Applications	
Application areas of capacitive sensors	6
Sensors	
Cylinder G6,5 DC	7
Cylinder M8 DC	8
Cylinder M12 DC	9
Cylinder M18 DC	11
Cylinder M18 AC/DC	13
Cylinder M30 DC	14
Cylinder M30 AC/DC	16
Cylinder G34 DC	17
Square Q40 DC	18
Product overview	
All sensors at a glance	20



NOTES



CAPACITIVE SENSORS

DESIGNATION CODE

Example: **K C 10 - M 30 M B 45 - D P S - V1 - X0000**

┆
┆
┆
┆
┆
┆
┆
┆
┆
┆
┆
┆
┆

1
2
3
4
5
6
7
8
9
10
11
12

1 = Working principle

A	Acoustic
B	Acceleration sensor
C	Capacitive
D	Strain gauge sensor
H	Hall-effect
J	Inductive
	JR Inductive ring
	JF Inductive surface
	JG Inductive slot
	JD Metalface
M	Magnetoresistive
N	Inclination sensor
R	Reed-contact
W	Angle sensor

2 = Switching distance / range

3 = Design

D	Ring housing
G	Cylindrical housing without thread
M	Cylindrical housing with metrical thread
Q	Square housing

4 = Housing diameter / edge length

5 = Housing material

A	Aluminium
E	Stainless steel
K	Plastic
M	Brass, nickel plated
T	PTFE

6 = Installation

B	Shielded
N	Non shielded

7 = Tube length

8 = Operating voltage

AZ	AC alternating current voltage
D	DC direct current voltage
VZ	AC/DC all voltages

9 = Type of output signal

AN	Analog	ANI	Current output
		ANU	Voltage output
CAN	CAN-bus interface		
N	NPN		
NA	Namur		
P	PNP		
Z	Two wire		

10 = Function

A	Changeover
I	Impulse output
Ö	N.C.
S	N.O.
U	Switchable

11 = Connection

V1	M8 screw-/snap-in
V2	M12 metal
V2/1	M12 plastic
V3	M5 metal
V4	Amphenol Tuchel
V6	Brad Harrison
V7	Valve connector type A
V8	M8 snap-in only
V9	Torson
V10	Valve connector type C
V11	AC connector 1/2" UNF
V12	M18 plastic
VE	Euchner connector
RS232	Data interface
PG	Thread joint PG
Mxx	Thread joint metrical

others as requested

12 = Additional marks

AM	Sensing face in centre
FE	Reduction 1 to steel / iron
HT	High temperature
NF	Reduction 1 to nonferrous metal
SF	Weld field immune
T	Enlarged temperature range
W	Angled sensing face / angled cable exit
X	Customized design with detailed description



CAPACITIVE SENSORS

CIRCUIT DIAGRAMS

Circuit diagram for	Cable / clamp connection	Connector V1 ... V9
DPS DC PNP N.O.		
DPÖ DC PNP N.C.		
DPA DC PNP changeover		
DPU DC NO/NC switchable		
DNS DC NPN N.O.		
DNÖ DC NPN N.C.		
DNA DC NPN changeover		
DNU DC NO/NC switchable		
NA Namur EN 60947-5-6		
DZS DC two-wire N.O.		
DZÖ DC two-wire N.C.		
AZS/VZS AC/DC two-wire N.O.		
AZÖ/VZÖ AC/DC two-wire N.C.		
Analog		



FUNCTIONAL DESCRIPTION

Capacitive sensors detect metallic and non-metallic, solid and fluid materials. They are used for object counting tasks, fill level measurement or for the detection of positions and objects. The functional principle of capacitive sensors is based on the variation of capacitance in the active field of the sensor due to the approach of the target. This active field consists of two electrodes. The design of the electrodes can be adapted to the design of the sensor. Illustration 1 shows electrodes in concentric arrangement.

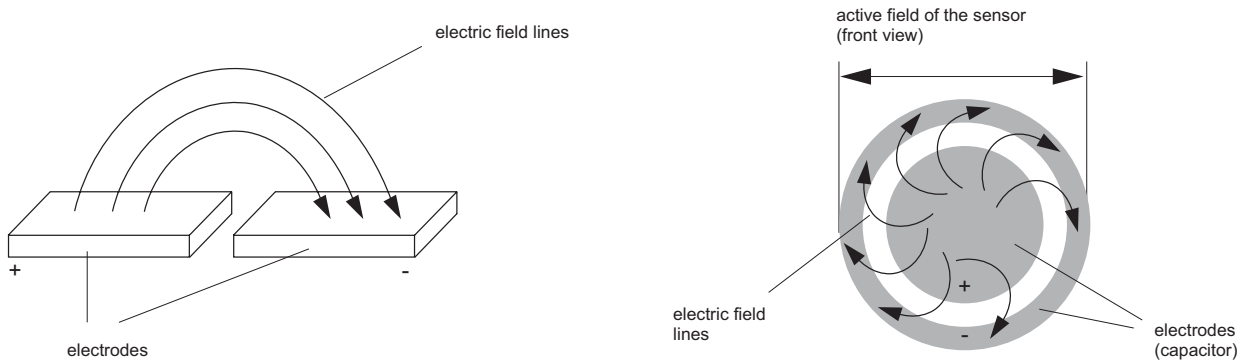

Functional principle opened capacitor plates

Application in capacitive sensors

Illustration 1: Arrangement of electrodes in capacitive sensors

The approach of a target on the active field of the sensor causes a variation of capacitance in the electric field of the sensor (illstr. 1). There are two different working principles for capacitive sensors

Principle 1 uses the damping of the electric field which is caused by the target. The target withdraws energy from the field. The degree of this loss of energy depends on the relative permittivity of the targets' material. The bigger this constant, the more energy is withdrawn from the field. The electronics in the sensor registrates this variation and switches when a certain threshold is attained.

Principle 2 is based on the stimulation of vibrations in a RC-oscillator by the approach of the target. The oscillator excites a high-frequency oscillation. When an object enters in this electric field the relative permittivity and the vibration behaviour of the oscillator change. The electronics in the sensor evaluates the emerging vibration and switches the sensor on, when a certain threshold is exceeded.

Capacitive sensors from Pulsotronic are available in N- and P-switching design and as normally closed or normally open contact. The sensitivity for different target materials and environmental conditions is adjusted via a potentiometer. The realisable switching distance depends on the target material.



APPLICATIONS

Fill level measurement

Measuring fill levels capacitive sensors provide a yes/no statement about the presence or absence of the test material. Targets can be fluid, powdery or granulated. Sensor 1 is situated outside of the filling zone and does not switch. Sensor 2 is situated below the fill level. The presence of material causes an activation of the oscillator. The sensor electronics evaluates that and switches. This arrangement allows a min-max-analysis. The interconnection of further sensors enables to user to achieve a finer grading of his measuring results. The sensors can be mounted shielded in non-metallic dividing walls. In metallic dividing walls non-shielded mounting is required.

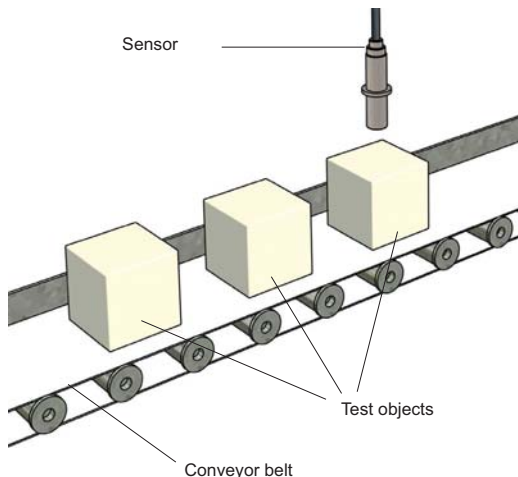
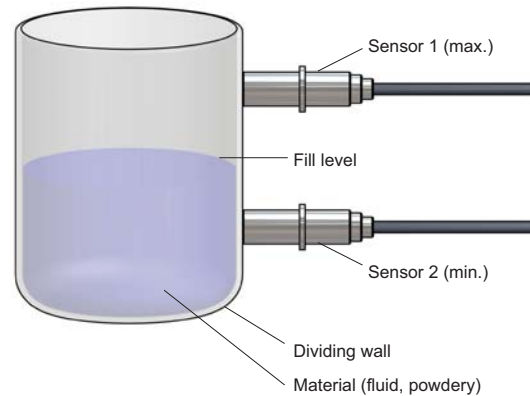

Counting tasks

The target entering in the electric field of the sensor causes a variation of the capacitance. The oscillator is excited respectively energy is withdrawn from the field. The sensor switches. When the test object leaves the sensing range, the oscillator takes its' normal value. The bigger the relative permittivity of the target material, the bigger the realisable switching distance in the application. The capacitive sensor provides unspecific, not material-related information. A statement concerning material, dimension or surface characteristics of the target is not possible with capacitive sensors.

Detection of positions

Objects moving in front of the sensor are detected when they reach a certain position. When the object enters in the electric field, the capacitance changes in dependence of the relative permittivity of the target material. The sensor switches.

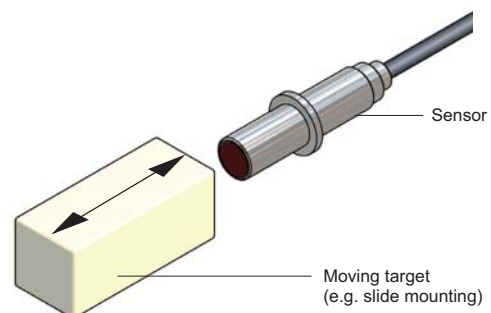



CAPACITIVE SENSORS

CYLINDER G6,5 DC

General data

Operating voltage U_b	10 ... 30V DC
Ripple voltage U_b	$\leq 10\%$
Voltage drop U_d	$\leq 2V$
Max. load current I_e	200mA
Off-state current I_o	$\leq 10mA$
Residual current I_r	$\leq 10\mu A$
Max. switching frequency f	100Hz
Hysteresis H	$\leq 15\%$
Repeatability R	$\leq 5\%$
Operating temperature T_a	$-25^\circ C \dots +70^\circ C$
Temperature drift	$\leq 10\%$
Protection class	IP67
EMV-standard	according to EN 60947-5-2
Switching state	LED
Housing material	brass, nickel-plated
Front cap	POM
Connection	2m cable PUR 3 x 0,15mm ²



Other cable lengths as requested.

Selection chart

Article number	Designation	Mounting	Output signal	Switching distance in mm	Drawing
08323650151	SC1,5-G6,5MB45-DPS	shielded	PNP	1,5	A
08323650152	SC1,5-G6,5MB45-DPÖ	shielded	PNP	1,5	A
08323650310	SC3-G6,5MN45-DPS	non shielded	PNP	3	B
08323650320	SC3-G6,5MN45-DPÖ	non shielded	PNP	3	B

Dimensions

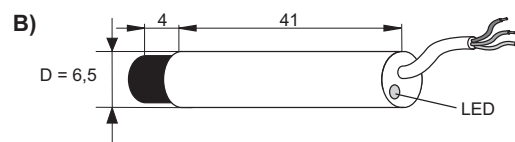
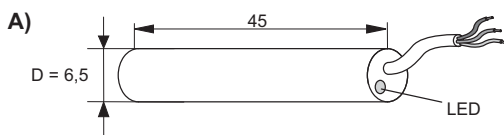

all data in mm



CYLINDER M8 DC

General data

Operating voltage U_b	10 ... 30V DC
Ripple voltage U_b	$\leq 10\%$
Voltage drop U_d	$\leq 2V$
Max. load current I_e	200mA
Off-state current I_o	$\leq 10mA$
Residual current I_r	$\leq 10\mu A$
Max. switching frequency f	100Hz
Hysteresis H	$\leq 15\%$
Repeatability R	$\leq 5\%$
Operating temperature T_a	-25°C ... +70°C
Temperature drift	$\leq 10\%$
Protection class	IP67
EMV-standard	according to EN 60947-5-2
Switching state	LED
Housing material	brass, nickel-plated
Front cap	POM
Connection	2m cable PUR 3 x 0,15mm ²



Other cable lengths as requested.

Selection chart

Article number	Designation	Mounting	Output signal	Switching distance in mm	Drawing
08323080151	SC1,5-M8MB45-DPS	shielded	PNP	1,5	A
08323080152	SC1,5-M8MB45-DPÖ	shielded	PNP	1,5	A
08323080310	SC3-M8MN45-DPS	non shielded	PNP	3	B
08323080320	SC3-M8MN45-DPÖ	non shielded	PNP	3	B

Dimensions

A)

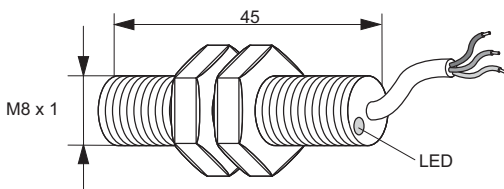

B)

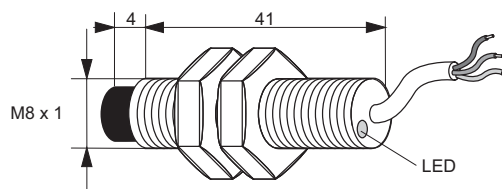

all data in mm



CAPACITIVE SENSORS

CYLINDER M12 DC

General data

Operating voltage U_b	10 ... 30V DC
Ripple voltage U_r	$\leq 10\%$
Voltage drop U_d	SC... $\leq 2V$ KC... $\leq 3V$
Max. load current I_e	200mA
Off-state current I_o	KC... $\leq 20mA$ SC... $\leq 10mA$
Residual current I_r	$\leq 10\mu A$
Max. switching frequency f	KC... 15Hz SC... 100Hz
Hysteresis H	$\leq 15\%$
Repeatability R	$\leq 5\%$
Operating temperature T_a	$-25^\circ C \dots +70^\circ C$
Temperature drift	$\leq 10\%$
Protection class	IP67
EMV-standard	according to EN 60947-5-2
Switching state	LED
Housing material	KC... PA 6.6 SC... brass, nickel-plated
Front cap	SC4... POM SC8... PBT



The drawings of these sensors are shown on the following page.

Selection chart

Article number	Designation switching distance 4mm	Mounting	Output signal	Connection	Drawing (next page)
0832000003	KC4-M12KN-DPS	non shielded	PNP	2m cable PCV 3 x 0,34mm ²	A
0832000019	KC4-M12KN-DPÖ	non shielded	PNP	2m cable PCV 3 x 0,34mm ²	A
08323120410	SC4-M12MB60-DPS	shielded	PNP	2m cable PCV 3 x 0,34mm ²	B
08323120420	SC4-M12MB60-DPÖ	shielded	PNP	2m cable PCV 3 x 0,34mm ²	B
08323120412	SC4-M12MB80-DPS-V2	shielded	PNP	connector M12 4-pole	B1
08323120422	SC4-M12MB80-DPÖ-V2	shielded	PNP	connector M12 4-pole	B1
	Designation switching distance 8mm				
08323120810	SC8-M12MN60-DPS	non shielded	PNP	2m cable PCV 3 x 0,34mm ²	C
08323120820	SC8-M12MN60-DPÖ	non shielded	PNP	2m cable PCV 3 x 0,34mm ²	C
08323120812	SC8-M12MN80-DPS-V2	non shielded	PNP	connector M12 4-pole	C1
08323120822	SC8-M12MN80-DPÖ-V2	non shielded	PNP	connector M12 4-pole	C1



CAPACITIVE SENSORS

CYLINDER M12 DC

Dimensions

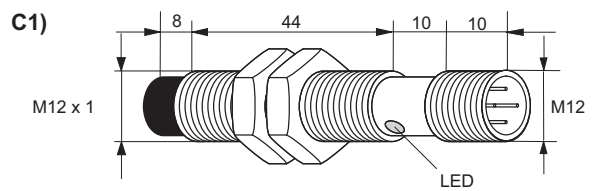
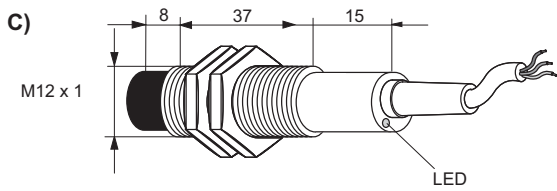
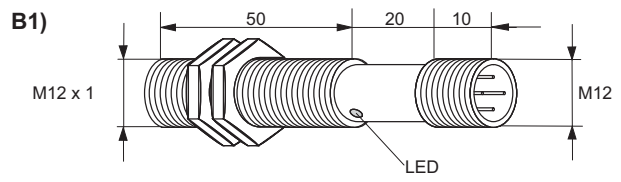
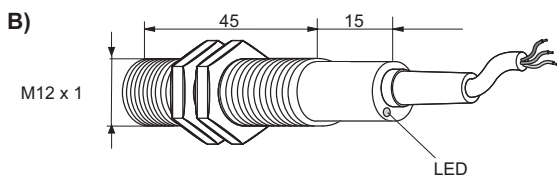
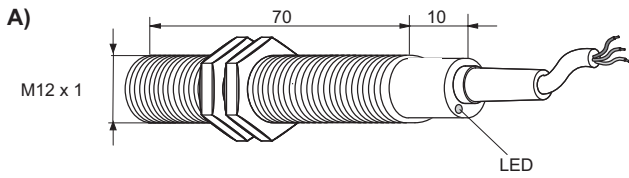

all data in mm

p-u-l-s-o-n-i-c
Pulsotronic GmbH & Co. KG

Neue Schichtstraße 14b
D-09366 Niederdorf

☎ +49 (0) 37296 / 930 - 200
☎ +49 (0) 37296 / 930 - 280

info@pulsotronic.de
www.pulsotronic.de

subject to
modifications!



CAPACITIVE SENSORS

CYLINDER M18 DC

General data

Operating voltage U_b	10 ... 30V DC
Ripple voltage U_r	$\leq 10\%$
Voltage drop U_d	SC... $\leq 2V$ KC... $\leq 3V$
Max. load current I_e	200mA
Off-state current I_o	KC... $\leq 20mA$ SC... $\leq 10mA$
Residual current I_r	$\leq 10\mu A$
Max. switching frequency f	KC... 10Hz SC... 100Hz
Hysteresis H	$\leq 15\%$
Repeatability R	$\leq 5\%$
Operating temperature T_a	$-25^\circ C \dots +70^\circ C$
Temperature drift	$\leq 10\%$
Protection class	IP67
EMV-standard	according to EN 60947-5-2
Switching state	LED
Housing material	KC... PA 6.6 SC... brass, nickel-plated
Front cap	SC... PBT



The drawings of these sensors are shown on the following page.

Other cable lengths as requested.

Selection chart

Article number	Designation switching distance 8mm	Mounting	Output signal	Connection	Drawing (next page)
08320000397	KC8-M18KN-DPS	non shielded	PNP	2m cable PCV 3 x 0,34mm ²	A
08320000407	KC8-M18KN-DPÖ	non shielded	PNP	2m cable PCV 3 x 0,34mm ²	A
08323180810	SC8-M18MB80-DPS	shielded	PNP	2m cable PCV 3 x 0,34mm ²	B
08323180820	SC8-M18MB80-DPÖ	shielded	PNP	2m cable PCV 3 x 0,34mm ²	B
08323180812	SC8-M18MB95-DPS-V2	shielded	PNP	connector M12 4-pole	B1
08323180822	SC8-M18MB95-DPÖ-V2	shielded	PNP	connector M12 4-pole	B1
	Designation switching distance 15mm				
08323181510	SC15-M18MN80-DPS	non shielded	PNP	2m cable PCV 3 x 0,34mm ²	C
08323181520	SC15-M18MN80-DPÖ	non shielded	PNP	2m cable PCV 3 x 0,34mm ²	C
08323181512	SC15-M18MN95-DPS-V2	non shielded	PNP	connector M12 4-pole	C1
08323181522	SC15-M18MN95-DPÖ-V2	non shielded	PNP	connector M12 4-pole	C1



CAPACITIVE SENSORS

CYLINDER M18 DC

Dimensions

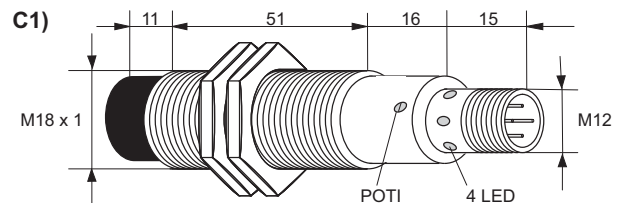
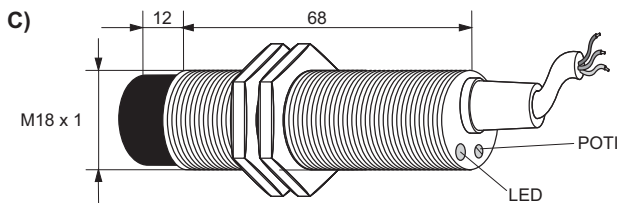
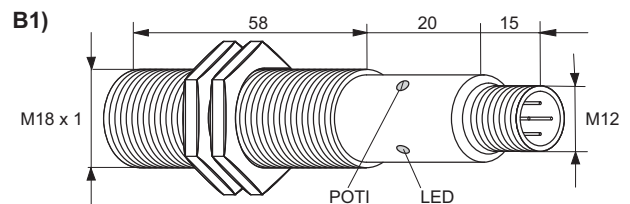
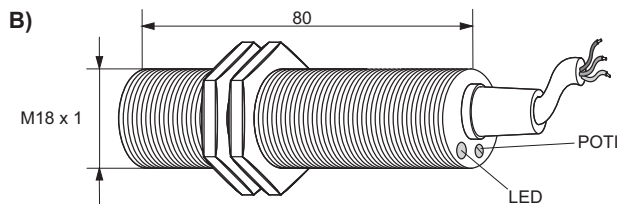
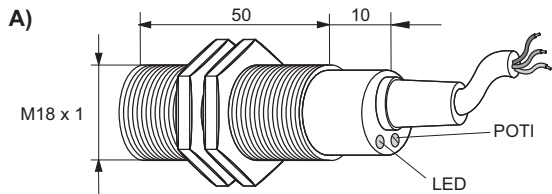

all data in mm



CAPACITIVE SENSORS

CYLINDER M18 AC/DC





General data

Operating voltage U_b	20 ... 250V AC/DC
Voltage frequency	50/60Hz
Voltage drop U_d	$\leq 10V$ DC / 8V AC
Max. load current I_e	200mA
Min. load current I_{emin}	5mA
Residual current I_r	$\leq 2,5mA$
Peak current I_k	2,2A (20ms)
Max. switching frequency f	AC 25Hz / DC 40Hz
Hysteresis H	$\leq 15\%$
Repeatability R	$\leq 1\%$
Operating temperature T_a	-25°C ... +70°C
Temperature drift	$\leq 1 - 15\%$
Protection class	IP67
EMV-standard	according to EN 60947-5-2
Switching state	LED
Housing material	brass, nickel-plated
Front cap	PBT
Connection	2m cable PVC 2 x 0,34mm ²



Other cable lengths as requested.

Selection chart

Article number	Designation switching distance 8mm	Mounting	Ausgangs- funktion	Connection	Drawing
08323180870	SC8-M18MB80-VZS	shielded	two wire 	2m cable PCV 3 x 0,34mm ²	A
08323180880	SC8-M18MB80-VZÖ	shielded	two wire 	2m cable PCV 3 x 0,34mm ²	A
Designation switching distance 15mm					
08323181570	SC15-M18MN80-VZS	non shielded	two wire 	2m cable PCV 3 x 0,34mm ²	B
08323181580	SC15-M18MN80-VZÖ	non shielded	two wire 	2m cable PCV 3 x 0,34mm ²	B

Dimensions

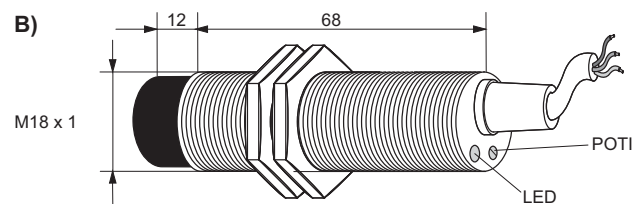
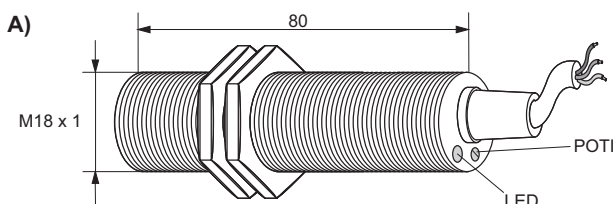

all data in mm



CAPACITIVE SENSORS

CYLINDER M30 DC

General data

Operating voltage U_b	10 ... 30V DC
Voltage frequency	$\leq 10\%$
Voltage drop U_d	SC... $\leq 2V$ KC... $\leq 3V$
Max. load current I_e	200mA
Off-state current I_0	KC... $\leq 20mA$ SC... $\leq 10mA$
Residual current I_r	$\leq 10\mu A$
Max. switching frequency f	KC... 10Hz SC... 100Hz
Hysteresis H	$\leq 15\%$
Repeatability R	$\leq 5\%$
operating temperature T_a	-25°C ... +70°C
Temperature drift	$\leq 10\%$
Protection class	IP67
EMV-standard	according to EN 60947-5-2
Switching state	LED
Housing material	KC... PA 6.6 SC... brass, nickel-plated
Front cap	SC... PBT



The drawings of these sensors are shown on the following page.

Other cable lengths as requested.

Selection chart

Article number	Designation switching distance 15mm	Mounting	Output signal	Connection	Drawing (next page)
0832000020	KC15-M30KN-DPS	non shielded	PNP	2m cable PCV 3 x 0,34mm ²	A
0832000035	KC15-M30KN-DPÖ	non shielded	PNP	2m cable PCV 3 x 0,34mm ²	A
	Designation switching distance 20mm				
08323302010	SC20-M30MB80-DPS	shielded	PNP	2m cable PCV 3 x 0,5mm ²	B
08323302020	SC20-M30MB80-DPÖ	shielded	PNP	2m cable PCV 3 x 0,5mm ²	B
08323302012	SC20-M30MB90-DPS-V2	shielded	PNP	connector M12 4-pole	B1
08323302022	SC20-M30MB90-DPÖ-V2	shielded	PNP	connector M12 4-pole	B1
	Designation switching distance 30mm				
08323303010	SC30-M30MN80-DPS	non shielded	PNP	2m cable PCV 3 x 0,5mm ²	C
08323303020	SC30-M30MN80-DPÖ	non shielded	PNP	2m cable PCV 3 x 0,5mm ²	C
08323303012	SC30-M30MN90-DPS-V2	non shielded	PNP	connector M12 4-pole	C1
08323303022	SC30-M30MN90-DPÖ-V2	non shielded	PNP	connector M12 4-pole	C1



CAPACITIVE SENSORS

CYLINDER M30 DC

Dimensions

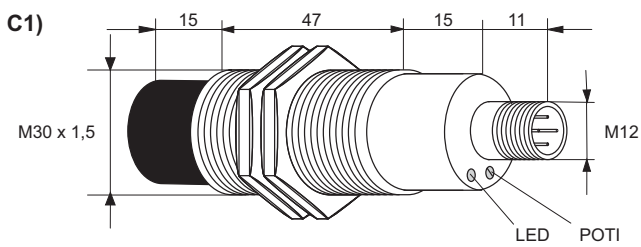
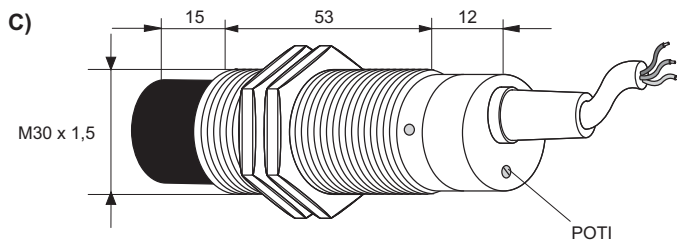
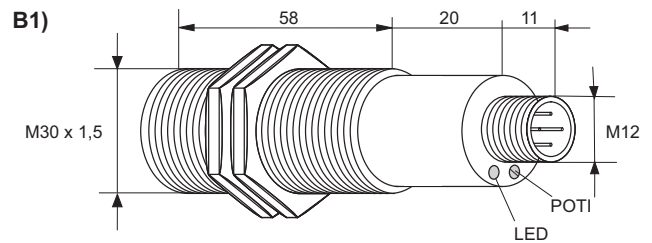
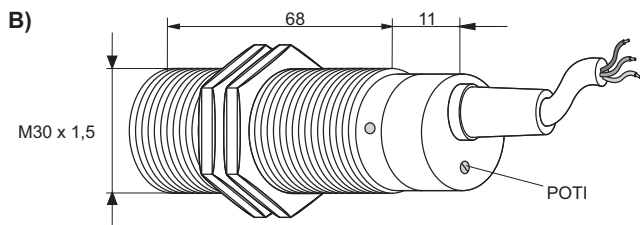
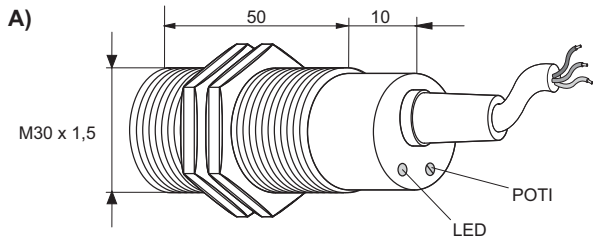

all data in mm



CAPACITIVE SENSORS

CYLINDER M30 AC/DC

General data

Operating voltage U_b	20 ... 250V AC/DC
Voltage frequency	50/60Hz
Voltage drop U_d	$\leq 10V$ DC / 8V AC
Max. load current I_e	200mA
Min. load current I_{emin}	5mA
Residual current I_r	$\leq 2,5mA$
Peak current I_k	2,2A (20ms)
Max. switching frequency f	AC 25Hz / DC 40Hz
Hysteresis H	$\leq 15\%$
Repeatability R	$\leq 1\%$
Operating temperature T_a	$-25^\circ C \dots +70^\circ C$
Temperature drift	$\leq 1 - 15\%$
Protection class	IP67
EMV-standard	according to EN 60947-5-2
Switching state	LED
Housing material	brass, nickel-plated
Front cap	PBT
Connection	2m cable PVC 2 x 0,34mm ²



Other cable lengths as requested.

Selection chart

Article number	Designation switching distance 15mm	Mounting	Output signal	Connection	Drawing
08323301570	SC15-M30MB80-VZS	shielded	two-wire	2m cable PCV 3 x 0,5mm ²	A
08323301580	SC15-M30MB80-VZÖ	shielded	two-wire	2m cable PCV 3 x 0,5mm ²	A
	Designation switching distance 20mm				
08323302070	SC20-M30MN80-VZS	non shielded	two-wire	2m cable PCV 3 x 0,5mm ²	B
08323302080	SC20-M30MN80-VZÖ	non shielded	two-wire	2m cable PCV 3 x 0,5mm ²	B

Dimensions

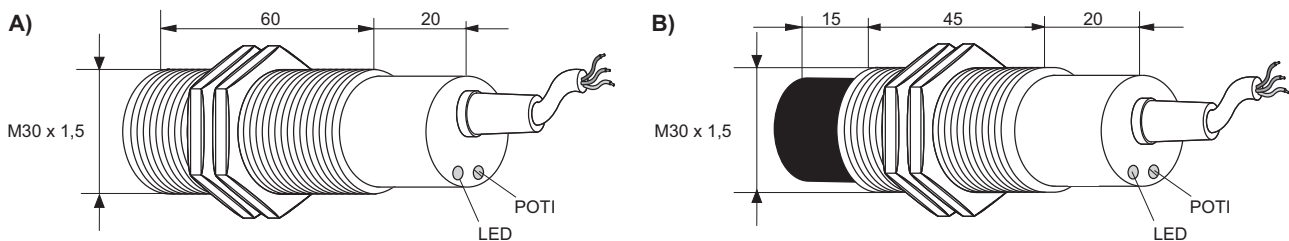

all data in mm

p-u-l-s-o-t-r-o-n-i-c
Pulsotronic GmbH & Co. KG

Neue Schichtstraße 14b
D-09366 Niederdorf

+49 (0) 37296 / 930 - 200
+49 (0) 37296 / 930 - 280

info@pulsotronic.de
www.pulsotronic.de

subject to
modifications!



CAPACITIVE SENSORS

CYLINDER G34 DC

General data

Operating voltage U_b	10 ... 30V DC
Ripple voltage U_b	$\leq 10\%$
Voltage drop U_d	$\leq 3V$
Max. load current I_e	200mA
Min. load current I_{emin}	$\leq 20mA$
Residual current I_r	$\leq 10\mu A$
Max. switching frequency f	10Hz
Hysteresis H	$\leq 15\%$
Repeatability R	$\leq 5\%$
Operating temperature T_a	-25°C ... +70°C
Temperature drift	$\leq 10\%$
Protection class	IP67
EMV-standard	according to IEC 60947-5-2
Switching state	LED
Housing material	PA 6,6



Other cable lengths as requested.

Selection chart

Article number	Designation	Mounting	Output signal	Switching distance in mm	Connection	Drawing
08329668400	KC20-G34KN-DPS	non shielded	PNP	20	2m cable PUR 3 x 0,34mm ²	A
08329668600	KC20-G34KN-DPÖ	non shielded	PNP	20	2m cable PUR 3 x 0,34mm ²	A
08320000016	KC20-G34KN-DPS-V2/1	non shielded	PNP	20	connector M12	B

Dimensions

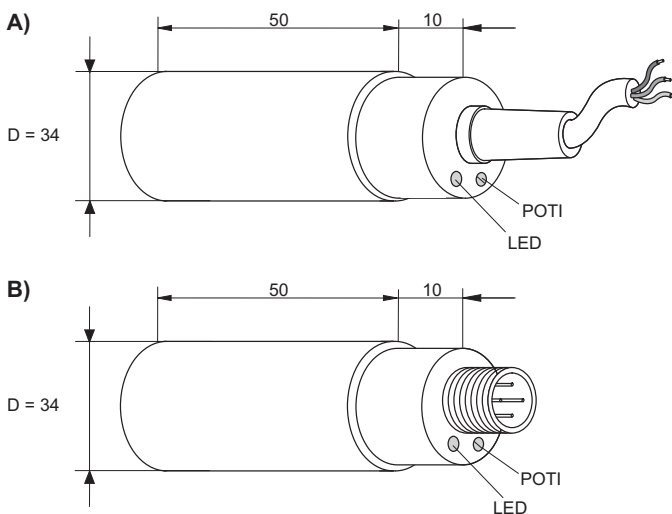

all data in mm



CAPACITIVE SENSORS

SQUARE Q40 DC

General data

Operating voltage U_b	10 ... 30V DC
Ripple voltage U_b	$\leq 10\%$
Voltage drop U_d	$\leq 2V$
Max. load current I_e	300mA
Off-state current I_0	$\leq 10mA$
Residual current I_r	$\leq 10\mu A$
Max. switching frequency f	100Hz
Hysteresis H	$\leq 15\%$
Repeatability R	$\leq 5\%$
Operating temperature T_a	-25°C ... +70°C
Temperature drift	$\leq 10\%$
Protection class	IP67
EMV-standard	according to EN 60947-5-2
Switching state	LED
Housing material	PBT



Selection chart

Article number	Designation switching distance 30mm	Mounting	Output signal	Connection	Drawing (next page)
08323443050	SC30-Q40KB-DPA	shielded	PNP	terminals 4 x 0,5mm ²	A
08323443052	SC30-Q40KB-DPA-V2	shielded	PNP	connector M12 4-pole	B
08323403052	SC30-Q40KB40-DPA-V2	shielded	PNP	connector M12 4-pole	C
	Designation switching distance 40mm				
08323404050	SC40-Q40KN-DPA	non shielded	PNP	terminals 4 x 0,5mm ²	A
08323404052	SC40-Q40KN-DPA-V2	non shielded	PNP	connector M12 4-pole	B
08323404152	SC40-Q40KN40-DPA-V2	non shielded	PNP	connector M12 4-pole	C



SQUARE Q40 DC

Dimensions

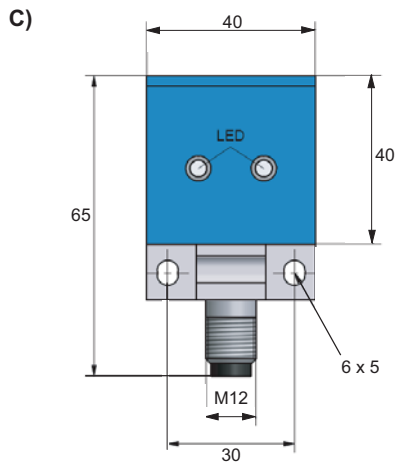
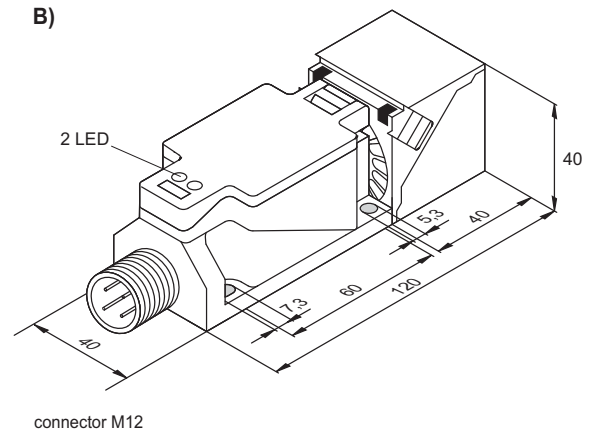
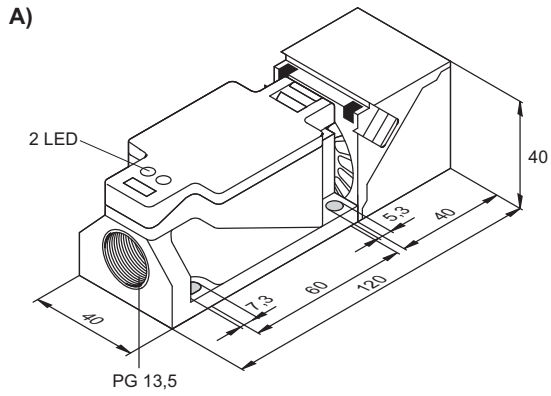

all data in mm



PRODUCT OVERVIEW

Product group	Designation	Article number	Matchcode	Page
Capacitive	SC1,5-G6,5MB45-DPS	08323650151		7
Capacitive	SC1,5-G6,5MB45-DPÖ	08323650152		7
Capacitive	SC1,5-M8MB45-DPS	08323080151		8
Capacitive	SC1,5-M8MB45-DPÖ	08323080152		8
Capacitive	SC3-G6,5MN45-DPS	08323650310		7
Capacitive	SC3-G6,5MN45-DPÖ	08323650320		7
Capacitive	SC3-M8MN45-DPS	08323080310		8
Capacitive	SC3-M8MN45-DPÖ	08323080320		8
Capacitive	SC4-M12MB60-DPS	08323120410		9
Capacitive	KC4-M12KN-DPS	08320000003		9
Capacitive	SC4-M12MB60-DPÖ	08323120420		9
Capacitive	KC4-M12KN-DPÖ	08320000019		9
Capacitive	SC4-M12MB80-DPS-V2	08323120412		9
Capacitive	SC4-M12MB80-DPÖ-V2	08323120422		9
Capacitive	SC8-M12MN60-DPS	08323120810		9
Capacitive	SC8-M12MN60-DPÖ	08323120820		9
Capacitive	SC8-M12MN80-DPS-V2	08323120812		9
Capacitive	SC8-M12MN80-DPÖ-V2	08323120822		9
Capacitive	SC8-M18MB80-VZS	08323180870		13
Capacitive	SC8-M18MB80-VZÖ	08323180880		13
Capacitive	SC8-M18MB80-DPS	08323180810		11
Capacitive	KC8-M18KN60-DPS	08320000397		11
Capacitive	SC8-M18MB80-DPÖ	08323180820		11
Capacitive	KC8-M18KN60-DPÖ	08320000407		11
Capacitive	SC8-M18MB95-DPS-V2	08323180812		11
Capacitive	SC8-M18MB95-DPÖ-V2	08323180822		11
Capacitive	SC15-M18MN80-VZS	08323181570		13
Capacitive	SC15-M18MN80-VZÖ	08323181580		13
Capacitive	SC15-M18MN80-DPS	08323181510		11
Capacitive	SC15-M18MN80-DPÖ	08323181520		11
Capacitive	SC15-M18MN95-DPS-V2	08323181512		11
Capacitive	SC15-M18MN95-DPÖ-V2	08323181522		11
Capacitive	SC15-M30MB80-VZS	08323301570		16
Capacitive	SC15-M30MB80-VZÖ	08323301580		16
Capacitive	KC15-M30KN60-DPS	08320000020		14
Capacitive	KC15-M30KN-DPÖ	08320000335		14
Capacitive	SC20-M30MN80-VZS	08323302070		16
Capacitive	SC20-M30MN80-VZÖ	08323302080		16
Capacitive	SC20-M30MB80-DPS	08323302010		14
Capacitive	SC20-M30MB80-DPÖ	08323302020		14
Capacitive	SC20-M30MB90-DPS-V2	08323302012		14
Capacitive	SC20-M30MB90-DPÖ-V2	08323302022		14
Capacitive	KC20-G34KN-DPS	08329668400		17
Capacitive	KC20-G34KN-DPÖ	08323768600		17
Capacitive	KC20-G34KN-DPS-V2/1	08320000016	9966-8463	17
Capacitive	SC30-M30MN80-DPS	08323303010		14
Capacitive	SC30-M30MN80-DPÖ	08323303020		14
Capacitive	SC30-M30MN90-DPS-V2	08323303012		14



PRODUCT OVERVIEW

Product group	Designation	Article number	Matchcode	Page
Capacitive	SC30-M30MN90-DPÖ-V2	08323303022		14
Capacitive	SC30-Q40KB-DPA	08323443050		18
Capacitive	SC30-Q40KB-DPA-V2	08323443052		18
Capacitive	SC30-Q40KB40-DPA-V2	08323403052		18
Capacitive	SC40-Q40KN-DPA	08323404050		18
Capacitive	SC40-Q40KN-DPA-V2	08323404052		18
Capacitive	SC40-Q40KN40-DPA-V2	08323404152		18

all data in mm

p-u-l-s-o-n-i-c
Pulsotronic GmbH & Co. KG

Neue Schichtstraße 14b
D-09366 Niederdorf

☎ +49 (0) 37296 / 930 - 200
☎ +49 (0) 37296 / 930 - 280

✉ info@pulsotronic.de
www.pulsotronic.de

subject to
modifications!