

ETH Electro Cylinder

Parker High Force Electro Thrust Cylinder



ENGINEERING YOUR SUCCESS.



WARNING – USER RESPONSIBILITY

FAILURE OR IMPROPER SELECTION OR IMPROPER USE OF THE PRODUCTS DESCRIBED HEREIN OR RELATED ITEMS CAN CAUSE DEATH, PERSONAL INJURY AND PROPERTY DAMAGE.

- This document and other information from Parker-Hannifin Corporation, its subsidiaries and authorized distributors provide product or system options for further investigation by users having technical expertise.
- The user, through its own analysis and testing, is solely responsible for making the final selection of the system and components and assuring that all performance, endurance, maintenance, safety and warning requirements of the application are met. The user must analyze all aspects of the application, follow applicable industry standards, and follow the information concerning the product in the current product catalog and in any other materials provided from Parker or its subsidiaries or authorized distributors.
- To the extent that Parker or its subsidiaries or authorized distributors provide component or system options based upon data or specifications provided by the user, the user is responsible for determining that such data and specifications are suitable and sufficient for all applications and reasonably foreseeable uses of the components or systems.

Overview	5
Technical Characteristics	8
Step by Step Selection Process	10
Calculating Required Axial Force	11
Selection of the Size and Screw Lead	12
ETH - Electro Thrust Cylinder for ATEX Environment	12
Service Life	13
Permissible Torque with motor in parallel	15
Permissible Axial Thrust Forces	16
Permissible Side Load	18
Stroke, Usable Stroke and Safety Travel	20
Relubrication	21
Dimensions	22
Motor Mounting Options ¹⁾	23
Motor and Gearbox Selection	26
Mounting Methods	27
Standard	27
Center Trunnion Mounting.....	27
Rear Clevis	28
Front Plate.....	30
Foot Mounting	31
Mounting Flanges	32
Cylinder Rod Version	33
External thread	33
Internal Thread	33
Spherical Rod Eye	34
Alignment Coupler.....	34
Outrigger Bearing - Parallel Guiding	35
Accessories	38
Force sensors - Spherical rod eye with integrated force sensor	38
Initiators / Limit Switches.....	41
Drive Train Selection	43
Example for Sizing with Predefined Drive Trains	43
Predefined Motion Packages ETH032	44
Predefined Motion Packages ETH050	46
Predefined Motion Packages ETH080	48
Predefined Motion Packages ETH100, ETH125	50
Order Code	52
ETH032 Preferred cylinder order code with reduced lead time.....	54
ETH050 Preferred cylinder order code with reduced lead time.....	55
ETH080 Preferred cylinder order code with reduced lead time.....	56

Parker Hannifin

The global leader in motion and control technologies

A world class player on a local stage

Global Product Design

Parker Hannifin has more than 40 years experience in the design and manufacturing of drives, controls, motors and mechanical products. With dedicated global product development teams, Parker draws on industry-leading technological leadership and experience from engineering teams in Europe, North America and Asia.

Local Application Expertise

Parker has local engineering resources committed to adapting and applying our current products and technologies to best fit our customers' needs.

Manufacturing to Meet Our Customers' Needs

Parker is committed to meeting the increasing service demands that our customers require to succeed in the global industrial market. Parker's manufacturing teams seek continuous improvement through the implementation of lean manufacturing methods throughout the process. We measure ourselves on meeting our customers' expectations of quality and delivery, not just our own. In order to meet these expectations, Parker operates and continues to invest in our manufacturing facilities in Europe, North America and Asia.

Electromechanical Worldwide Manufacturing Locations

Europe

Littlehampton, United Kingdom
Dijon, France
Offenburg, Germany
Filderstadt, Germany
Milan, Italy

Asia

Wuxi, China
Jangan, Korea
Chennai, India

North America

Rohnert Park, California
Irwin, Pennsylvania
Charlotte, North Carolina
New Ulm, Minnesota



Offenburg, Germany

Local Manufacturing and Support in Europe

Parker provides sales assistance and local technical support through a network of dedicated sales teams and authorized technical distributors throughout Europe.

For contact information, please refer to the Sales Offices on the back cover of this document or visit www.parker.com



Milan, Italy



Littlehampton, UK



Filderstadt, Germany



Dijon, France

High Force Electro Thrust Cylinder - ETH

Overview

Description

The ETH electro cylinder closes the gap between pneumatic and hydraulic actuators; it can act as a suitable alternative to both in many applications and can have the added benefit of increasing the reliability of the production process. Taking the costs for air and oil into consideration, you will find that in most cases an electromechanical system such as the ETH electro cylinder offers the more economical solution. Combined with a wide choice of accessories, the ETH becomes a highly customisable solution, suitable for a variety of applications.

Typical applications



- **Material handling and feed systems**
 - wood working and plastics industries
 - vertical actuators for loading machine tools
 - in the textile industry for tensioning / gripping textile fabrics
 - in the automotive industry for transporting and feeding components
- **Testing equipment and laboratory applications**
- **Valve and flap actuation**
- **Pressing**
- **Packaging machinery**
- **Process automation in the food and beverage industry**

Features

- **Unrivalled power density - high forces and small frame sizes**
- **Cabling can be concealed in the profile**
- **Accessories with integrated force sensors help to spread and even to control forces precisely**
- **Optimized for safe handling and simple cleaning**
- **High service life**
- **Reduced maintenance costs thanks to lubricating access in the cylinder flange**
- **Easy replacement due to pneumatic ISO flange norm (DIN ISO 15552:2005-12) conformity**
- **Integrated anti-rotation device**
- **Reduced noise emission**
- **All from one source:**
We offer the complete drive train: Drive controllers, motors and gearboxes to match the Electro Cylinder



Technical Characteristics - Overview

Type	ETH Electro Cylinder
Frame sizes	ETH032 / ETH050 / ETH080 / ETH100 / ETH125
Screw lead	5, 10, 16, 20 mm
Stroke	up to 2000 mm
Traction/thrust force	up to 114000 N
Speed	up to 1.3 m/s
Acceleration	up to 15 m/s ²
Equivalent dynamic axial force at a lifetime of 2500 km	up to 49600 N
Efficiency	up to 90 %
Repeatability	up to ± 0.03 mm
Protection classes	IP54 IP54 with stainless steel screws IP65
Drive	Inline: Axial drive or parallel drive with high performance toothed belt
Directives	2011/65/EC: Conform to RoHS  2014/34/EU Equipment group II Category 2, authorized for gas atmospheres zone 1 and zone 2
Classification	ETH032, 050:  II 2G Ex h IIC T4 Gb ETH080*:  II 2G Ex h IIB T4 Gb Conformity certificate number: EPS 13 ATEX 2 592 X (X: there are special specification of use, please observe the intended use of the ATEX Cylinder)

* ETH100,ETH125: on request only

We also offer customized solutions:

If your application requires a special version of the ETH cylinder, please contact your local Parker Sales Office.

- Customized mountings and rod ends
- Mounting of customer motors
- Preparation of the cylinder for use under aggressive environmental conditions
- Overlong thrust rod
- Polished thrust rod
- Thrust rod hard-chrome plated

Parker High Force Electro Thrust Cylinder

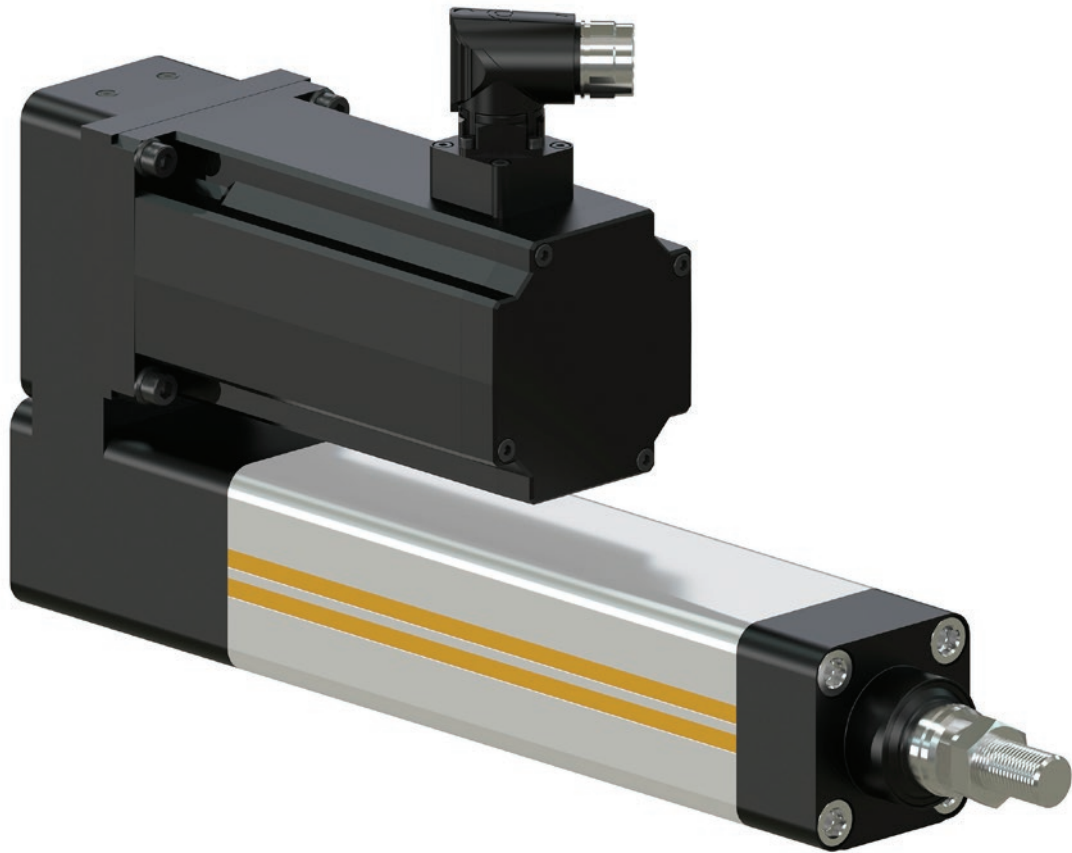

ETH IP54 (Standard)¹⁾

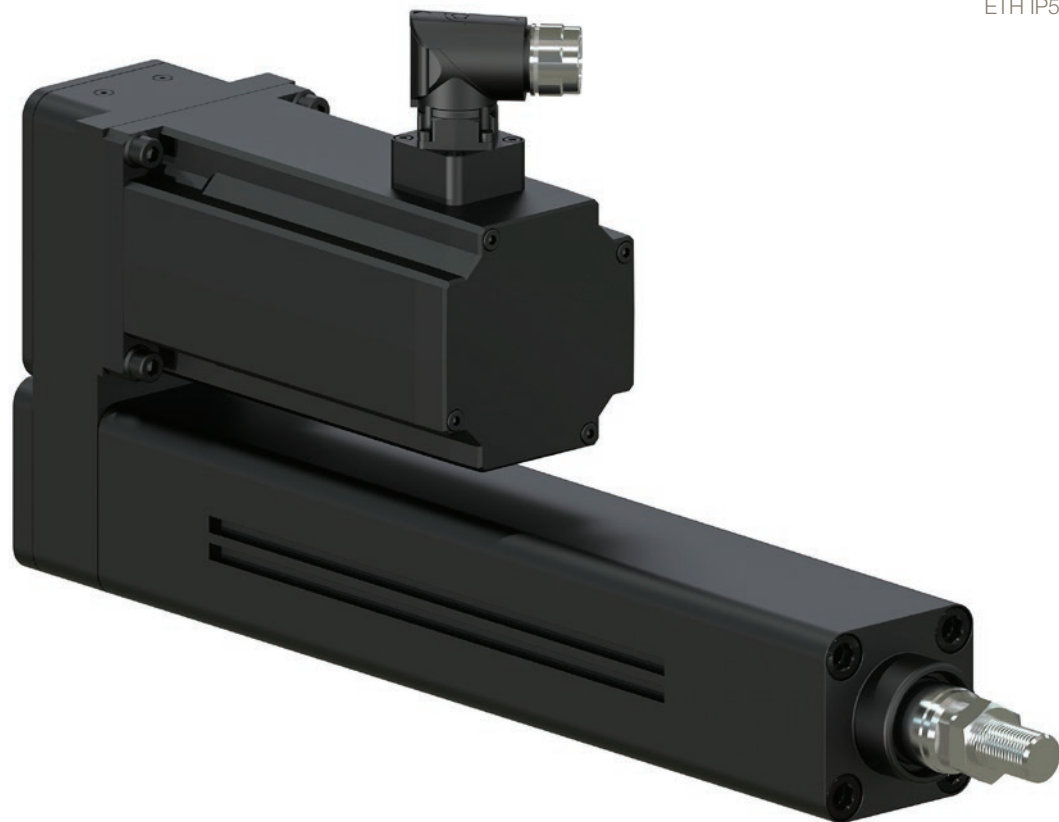

ETH IP65

¹⁾ ETH032/050/080 ATEX: End caps and drive housing are not anodized

Product Design

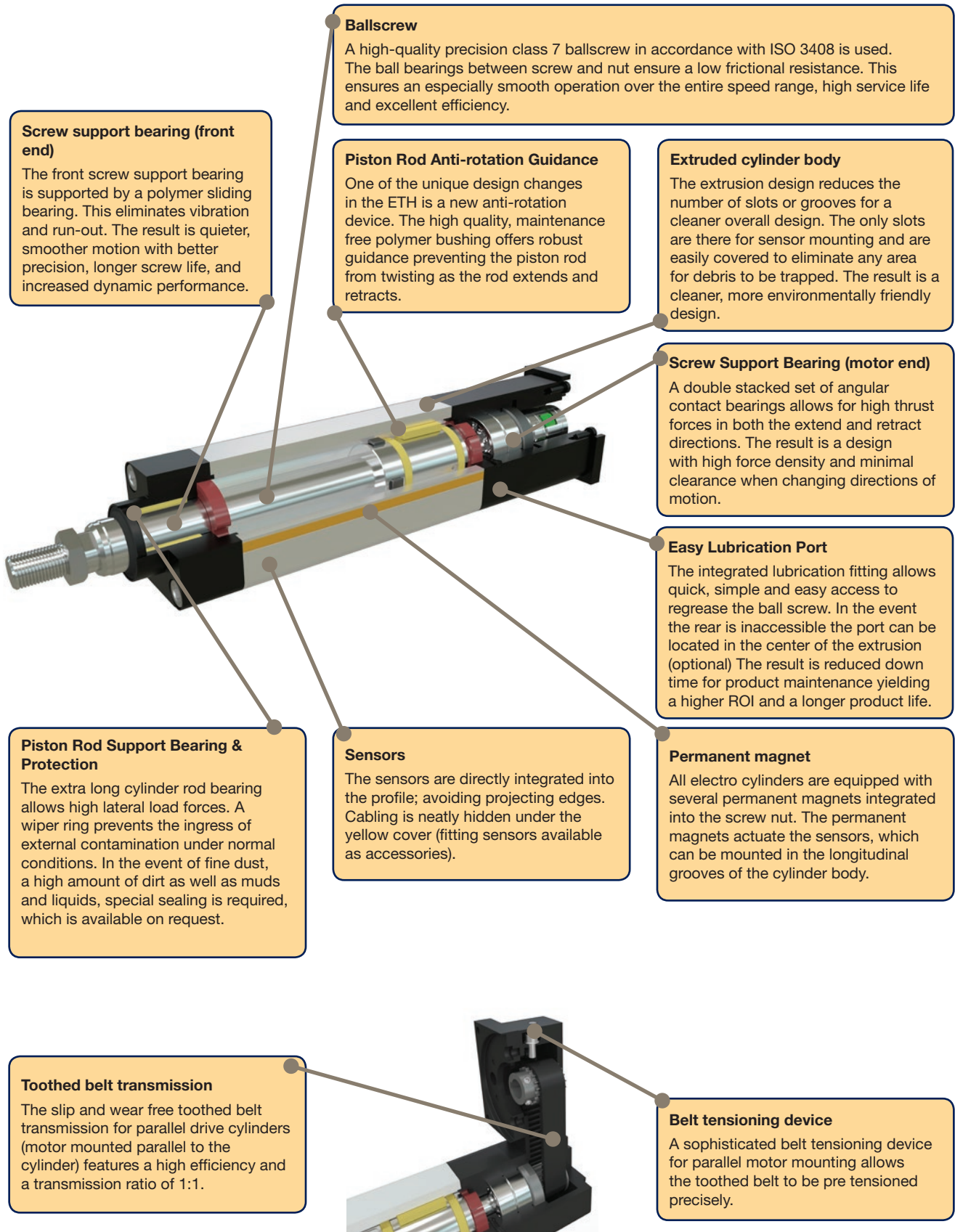

Ballscrew

A high-quality precision class 7 ballscrew in accordance with ISO 3408 is used. The ball bearings between screw and nut ensure a low frictional resistance. This ensures an especially smooth operation over the entire speed range, high service life and excellent efficiency.

Screw support bearing (front end)

The front screw support bearing is supported by a polymer sliding bearing. This eliminates vibration and run-out. The result is quieter, smoother motion with better precision, longer screw life, and increased dynamic performance.

Piston Rod Anti-rotation Guidance

One of the unique design changes in the ETH is a new anti-rotation device. The high quality, maintenance free polymer bushing offers robust guidance preventing the piston rod from twisting as the rod extends and retracts.

Extruded cylinder body

The extrusion design reduces the number of slots or grooves for a cleaner overall design. The only slots are there for sensor mounting and are easily covered to eliminate any area for debris to be trapped. The result is a cleaner, more environmentally friendly design.

Screw Support Bearing (motor end)

A double stacked set of angular contact bearings allows for high thrust forces in both the extend and retract directions. The result is a design with high force density and minimal clearance when changing directions of motion.

Easy Lubrication Port

The integrated lubrication fitting allows quick, simple and easy access to regrease the ball screw. In the event the rear is inaccessible the port can be located in the center of the extrusion (optional). The result is reduced down time for product maintenance yielding a higher ROI and a longer product life.

Piston Rod Support Bearing & Protection

The extra long cylinder rod bearing allows high lateral load forces. A wiper ring prevents the ingress of external contamination under normal conditions. In the event of fine dust, a high amount of dirt as well as muds and liquids, special sealing is required, which is available on request.

Sensors

The sensors are directly integrated into the profile; avoiding projecting edges. Cabling is neatly hidden under the yellow cover (fitting sensors available as accessories).

Permanent magnet

All electro cylinders are equipped with several permanent magnets integrated into the screw nut. The permanent magnets actuate the sensors, which can be mounted in the longitudinal grooves of the cylinder body.

Toothed belt transmission

The slip and wear free toothed belt transmission for parallel drive cylinders (motor mounted parallel to the cylinder) features a high efficiency and a transmission ratio of 1:1.

Belt tensioning device

A sophisticated belt tensioning device for parallel motor mounting allows the toothed belt to be pre tensioned precisely.

Technical Characteristics

Cylinder size type	Unit	ETH032			ETH050			ETH080	
		M05	M10	M16 ⁴⁾	M05	M10	M20 ⁴⁾	M05	M10
Screw lead	[mm]	5	10	16	5	10	20	5	10
Screw diameter	[mm]	16			20			32	

Travels, speeds and accelerations

Available strokes ¹⁾²⁾	[mm]	continuous from 50-1000 & standard strokes			continuous from 50-1200 & standard strokes			continuous from 100-1600 & standard strokes	
Max. permissible speed at stroke =									
50-400 mm	[mm/s]	333	667	1067	333	667	1333	267	533
600 mm	[mm/s]	286	540	855	333	666	1318	267	533
800 mm	[mm/s]	196	373	592	238	462	917	267	533
1000 mm	[mm/s]	146	277	440	177	345	684	264	501
1200 mm	[mm/s]	-	-	-	139	270	536	207	394
1400 mm	[mm/s]	-	-	-	-	-	-	168	320
1600 mm	[mm/s]	-	-	-	-	-	-	140	267
Max. Acceleration	[m/s ²]	4	8	12	4	8	15	4	8

Forces

Max. axial traction/thrust force motor inline	[N]		3700	2400		7000	4400		25 100
Max. axial traction/thrust force ³⁾ Motor parallel	[N]	3600	3280	2050	9300	4920	2460	17 800	11 620
Equivalent dynamic axial force at a lifetime of 2500 km	[N]	1130	1700	1610	2910	3250	2740	3140	7500

Max. transmissible torque / force constant

Max. transmissible torque inline motor	[Nm]	3.2	6.5	6.8	8.2	12.4	15.6	15.7	44.4
Max. transmissible torque ³⁾ Motor parallel	[Nm]	3.5	6.4		9.1	9.3		17.5	22.8
Force constant motor inline ⁵⁾	[N/Nm]	1131	565	353	1131	565	283	1131	565
Force constant motor parallel ⁵⁾	[N/Nm]	1018	509	318	1018	509	254	1018	509

Weight ⁶⁾

Weight of base unit with zero stroke (incl. piston rod)	[kg]	1.2	1.2	1.4	2.2	2.2	2.4	7.1	7.5
Additional weight of inline unit	[kg]	0.7			1.0			3.2	
Additional weight of parallel unit	[kg]	0.8			1.0			3.1	
Mass of additional stroke (incl. piston rod)	[kg/m]	4.5			8.2			18.2	
Weight of piston rod with zero stroke	[kg]	0.06			0.15			0.59	
Weight of piston rod - additional length	[kg/m]	0.99			1.85			4.93	

Mass moments of inertia

Motor parallel without stroke	[kgmm ²]	8.3	8.8	14.1	30.3	30.6	38.0	215.2	213.6
Motor inline without stroke	[kgmm ²]	7.1	7.6	12.9	25.3	25.7	33.1	166.2	164.5
Parallel/inline motor per meter	[kgmm ² /m]	41.3	37.6	41.5	97.7	92.4	106.4	527.7	470.0

Accuracy: Bidirectional Repeatability (ISO230-2)

Motor inline	[mm]	±0.03							
Motor parallel	[mm]	±0.05							

Efficiency

Motor inline	the efficiency includes all friction torques	[%]	90						
Motor parallel		[%]	81						

Ambient conditions

Operating Temperature	[°C]	-10...+70							
Ambient temperature	[°C]	-10...+40							
Storage temperature	[°C]	-20...+40							
Humidity	[%]	0...95 % (non-condensing)							
Location height range	[m]	max. 3000							

¹⁾ "Order Code" (page 52) & "Preferred Stroke Length" (page 54), ²⁾ Intermediate stroke lengths may be interpolated.

³⁾ Applies only for motor speed < 100 min⁻¹. Transmissible torque depending on the motor speed n Motor parallel see page 15,

⁴⁾ ATEX on request only, ⁵⁾ The efficiency factors are included in the force constants.

⁶⁾ Weight without rod-end and mounting option.

Cylinder size type	Unit	ETH100 ⁴⁾		ETH125 ⁴⁾	
		M10	M20	M10	M20
Screw lead	[mm]	10	20	10	20
Screw diameter	[mm]	50		63	

Travels, speeds and accelerations

Available strokes ^{1) 2)}	[mm]	continuous from 200-2000 & standard strokes		continuous from 200-2000 & standard strokes	
Max. permissible speed at stroke =					
100-400 mm	[mm/s]	400	800	417	833
500 mm	[mm/s]	400	747	417	807
600 mm	[mm/s]	333	622	395	684
800 mm	[mm/s]	241	457	290	514
1000 mm	[mm/s]	185	354	224	405
1200 mm	[mm/s]	148	284	180	329
1400 mm	[mm/s]	122	235	148	275
1600 mm	[mm/s]	102	198	125	234
2000 mm	[mm/s]	76	148	94	170
Max. Acceleration	[m/s ²]	8	10	8	10

Forces

Max. axial traction/thrust force motor inline	[N]	54 800	56 000	88 700	114 000
Max. axial traction/thrust. ³⁾ Motor parallel	[N]		50 800	76 300	81 400
Equivalent dynamic axial force at a lifetime of 2500 km	[N]	18 410	27 100	27 140	49 600

Max. transmissible torque / force constant

Max. transmissible torque inline motor	[Nm]	100	200	150	400
Max. transmissible torque. ³⁾ Motor parallel	[Nm]	108	200	150	320
Force constant motor inline ⁵⁾	[N/Nm]	565	283	565	283
Force constant motor parallel ⁵⁾	[N/Nm]	509	254	509	254

Weight ⁶⁾

Weight of base unit with zero stroke (incl. piston rod)	[kg]	21	24	56	64
Additional weight of inline unit	[kg]	12		27	
Additional weight of parallel unit	[kg]	21		51	
Mass of additional stroke (incl. piston rod)	[kg/m]	38		62	
Weight of piston rod with zero stroke	[kg]	1.2		2.9	
Weight of piston rod - additional length	[kg/m]	7.7		14.4	

Mass moments of inertia

Motor parallel without stroke	[kgmm ²]	5860	6240	17 050	17 990
Motor inline without stroke	[kgmm ²]	2240	2620	12 960	13 400
Parallel/inline motor per meter	[kgmm ² /m]	4270	4710	10 070	10 490

Accuracy: Bidirectional Repeatability (ISO230-2)

Motor inline	[mm]	±0.03			
Motor parallel	[mm]	±0.05			

Efficiency

Motor inline	the efficiency includes all friction torques	[%]	90		
Motor parallel		[%]	81		

Ambient conditions

Operating Temperature	[°C]	-10...+70			
Ambient temperature	[°C]	-10...+40			
Storage temperature	[°C]	-20...+40			
Humidity	[%]	0...95 % (non-condensing)			
Location height range	[m]	max. 3000			

¹⁾ "Order Code" (page 52), ²⁾ Intermediate stroke lengths may be interpolated.

³⁾ Applies only for motor speed < 100 min⁻¹. Transmissible torque depending on the motor speed n Motor parallel see page 15,

⁴⁾ ATEX on request only, ⁵⁾ The efficiency factors are included in the force constants, ⁶⁾ Weight without rod-end and mounting option..

Technical Data apply under normal conditions and only for the individual operating and load modes. In the case of compound loads, it is necessary to verify in accordance with normal physical laws and technical standards whether individual ratings should be reduced. In case of doubt please contact Parker.

Step by Step Selection Process

The following steps help you to specify the most suitable electro cylinder for your application. If your application's requirements exceed a maximum value, please choose a larger electro cylinder and recheck the maximum values. In some cases a smaller electro cylinder can also meet the requirements.

Step	Application data	Selection	With the aid of ...
1	ATEX or non-ATEX environment	If used in an ATEX environment, check if the ETH corresponds to the ATEX requirements of your application	"Electro Thrust Cylinder for ATEX Environment" (page 12)
2	Accuracy, ambient conditions	Check the basic conditions for the ETH in your application.	"Technical Characteristics" (page 8)
3	Required space	Check the space available in your application and select a motor mounting option: inline or parallel.	"Dimensions" (page 22)
4	Axial forces	Calculate the axial forces at different points in the application cycle.	"Calculating Required Axial Force" (page 11)
5	Maximum force required	Determine the maximum required axial force (traction and thrust force)	Determination of the maximum required axial force (page 12)
		Select the cylinder using the maximum axial traction/thrust force (please use the characteristics of your desired motor mounting option: inline or parallel).	"Technical Characteristics" (page 8)
6	Maximum speed	Select the screw lead for the desired cylinder.	"Technical Characteristics" (page 8)
7	Maximum Acceleration	Check if the maximum acceleration is sufficient.	"Technical Characteristics" (page 8)
8	Select stroke	Select the desired stroke: Determine required stroke from 'usable stroke and safety travels'. Select the desired stroke from the list of standard strokes or, if the desired stroke is not listed, define the length of the usable stroke in steps of one mm. Caution! Please respect the minimum and the maximum possible stroke.	"Stroke, Usable Stroke and Safety Travel" (page 20) "Order Code" (page 52) "Preferred Stroke Length" (page 54) "Technical Characteristics" (page 8)
9	Permissible thrust force taking the buckling risk into consideration	Check the maximum thrust force depending on the stroke and the mounting variant. Check if your application can also utilize a different mounting variant allowing to attain the maximum thrust force.	"Permissible Side Load" (page 18)
10	Service life	Determine the service life with the aid of an equivalent axial force, the operational environment (application factor) and the service life diagrams.	"Service Life" (page 13)
11	Permissible side load	Determine the lateral forces of your application and compare them to the permissible lateral forces (depending on the stroke).	Side load (page 18) Diagrams (page 18)
12	Relubricating cycle	Check if the required relubricating cycle is suitable for your production environment.	"Relubrication" (page 21)
13	Motor / gearbox	Calculate the necessary torque to generate the required force at the ETH. Select a suitable motor.	"Motor and Gearbox Selection" (page 26)
14	Motor mounting flange	Select a suitable motor mounting flange.	"Motor Mounting Options" (page 23)
15	Mounting type	Select the electro cylinder mounting method.	"Mounting Methods" (page 27)
16	Cylinder rods	Select the cylinder rod end for load mounting.	"Cylinder Rod Version" (page 33)

Calculating Required Axial Force

Formulas 1 & 2 below give the mathematical equation for calculating the thrust required to extend or retract the piston rod.

With the aid of the axial forces, it is possible to check if the electro cylinder is able to provide the required forces and if the maximum buckling load is respected. The axial forces are also used as the calculation basis for the service life.

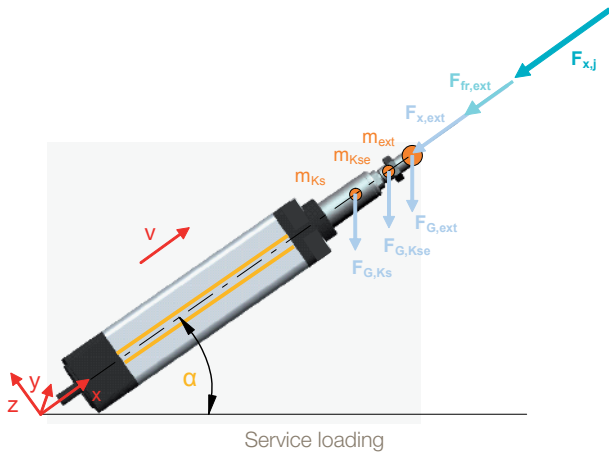

Formula symbols (Formula 1-2)

$F_{x,a,j}$	= Axial forces during extension in N
$F_{x,e,j}$	= Axial forces during retraction in N
$F_{x,ext}$	= External axial force in N
$F_{G,ext}$	= Weight force caused by an additional mass in N
$F_{G,Kse}$	= Weight force caused by the cylinder rod end in N
$F_{G,Ks}$	= Weight force caused by the cylinder rod in N
m_{ext}	= Additional mass in kg
m_{Kse}	= Mass of the cylinder rod end in kg (see "Cylinder Rod Version" page 33)
$m_{Ks,0}$	= Mass of the cylinder rod at zero stroke in kg (see table "Technical Data" page 8)
$m_{Ks,stroke}$	= Mass of the cylinder rod per mm of stroke in kg (see table "Technical Data" page 8)
Stroke	= Selected stroke in m
$a_{k,j}$	= Acceleration at the cylinder rod in m/s^2
α	= Alignment angle in $^\circ$
$F_{x,max}$	= Maximum permissible axial force in N
$F_{fr,ext}$	= External friction force in N

Index "j" for the individual segments of the application cycle

Calculation of axial forces

Determine the axial forces occurring during each individual segment of the application cycle.

Cylinder rod extending:

$$F_{x,a,j} = F_{x,ext} + F_{fr,ext} + (m_{ext} + m_{Kse} + m_{Ks,0} + m_{Ks,Stroke} \cdot \text{Stroke}) \cdot (a_{k,j} + \sin\alpha \cdot 9.81 \frac{m}{s^2})$$

Formula 1

Cylinder rod retracting:

$$F_{x,e,j} = F_{x,ext} - F_{fr,ext} + (m_{ext} + m_{Kse} + m_{Ks,0} + m_{Ks,Stroke} \cdot \text{Stroke}) \cdot (-a_{k,j} + \sin\alpha \cdot 9.81 \frac{m}{s^2})$$

Formula 2

Sample calculation:

Vertical mounting

- ETH050
- Stroke = 500 mm = 0.5 m
- Pitch = 5 mm
- Rod End: External thread
- Trapezoidal velocity course
- Acceleration $a_k = 4 m/s^2$
- $m_{ext} = 150 kg$
- $F_{x,ext} = 1000 N$
- $m_{Kse} = 0.15 kg$
- $m_{Ks,0} = 0.15 kg$
- $m_{Ks,Stroke} = 1.85 kg/m$
- Alignment angle $\alpha = -90^\circ$
- External friction force = 30 N

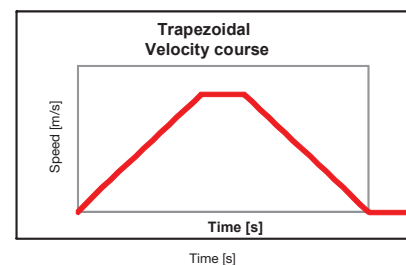

Thrust rod moving forth: Mass is moved downwards

Load case: Acceleration

$$F_{x,a,1} = 1000N + 30N + \left(150kg + 0.15kg + 0.15kg + 1.85 \frac{kg}{m} \cdot 0.5m\right) \cdot \left(4 \frac{m}{s^2} + \sin(-90^\circ) \cdot 9.81 \frac{m}{s^2}\right) = 151N$$

Load case: Constant Velocity

$$F_{x,a,2} = 1000N + 30N + \left(150kg + 0.15kg + 0.15kg + 1.85 \frac{kg}{m} \cdot 0.5m\right) \cdot \left(0 \frac{m}{s^2} + \sin(-90^\circ) \cdot 9.81 \frac{m}{s^2}\right) = -454N$$

Load case: Deceleration

$$F_{x,a,3} = 1000N + 30N + \left(150kg + 0.15kg + 0.15kg + 1.85 \frac{kg}{m} \cdot 0.5m\right) \cdot \left(-4 \frac{m}{s^2} + \sin(-90^\circ) \cdot 9.81 \frac{m}{s^2}\right) = -1058N$$

Thrust rod moving back: Mass is moved upwards

Load case: Acceleration

$$F_{x,e,4} = 1000N - 30N + \left(150kg + 0.15kg + 0.15kg + 1.85 \frac{kg}{m} \cdot 0.5m\right) \cdot \left(-4 \frac{m}{s^2} + \sin(-90^\circ) \cdot 9.81 \frac{m}{s^2}\right) = -1118N$$

Load case: Constant Velocity

$$F_{x,e,5} = 1000N - 30N + \left(150kg + 0.15kg + 0.15kg + 1.85 \frac{kg}{m} \cdot 0.5m\right) \cdot \left(0 \frac{m}{s^2} + \sin(-90^\circ) \cdot 9.81 \frac{m}{s^2}\right) = -514N$$

Load case: Deceleration

$$F_{x,e,6} = 1000N - 30N + \left(150kg + 0.15kg + 0.15kg + 1.85 \frac{kg}{m} \cdot 0.5m\right) \cdot \left(4 \frac{m}{s^2} + \sin(-90^\circ) \cdot 9.81 \frac{m}{s^2}\right) = 91N$$

Selection of the Size and Screw Lead

Required maximum axial force

Determine the maximum axial force (page 11) that the electro cylinder must provide.

Preselection of the electro cylinder

Using the calculated force required, compare the actual electro cylinder specifications (page 8) to determine which profile size will produce enough force.

Once you have determined a profile size, determine that the unit will physically fit in the space allowed by the application (including parallel or inline motor mounts).

Required maximum velocity

The maximum velocity of the electro cylinder depends on the stroke.

With the profile size selected, refer to the critical speed information (page 8) to determine which screw lead works best for the application at the needed stroke length.

When the precise stroke is defined, the velocity must again be verified.

Required maximum acceleration

The maximum acceleration depends on the screw lead and serves as an additional selection criterion for the suitable electro cylinder. It is listed in the "Technical Data" (page 8).

ETH - Electro Thrust Cylinder for ATEX Environment

Parker Hannifin has extended its well known ETH - High Force Electro Thrust Cylinder for the use in explosive atmospheres (ATEX). The new ETH ATEX offers all advantages of the well know ETH Electro Thrust Cylinder and offers even in explosive atmospheres precise motion, positioning, setting and actuating.

The ETH ATEX range is ATEX certified for device group II, category 2 in explosive gas atmospheres. In conjunction with the ATEX certified EX series servomotors, Parker Hannifin offers a complete drive package for such applications.



Target Market / Applications

An ATEX environment contains a mixture of air and flammable substances such as gas, vapor or fluids which are potentially explosive under atmospheric conditions. ATEX certificated devices are essential for the use under this conditions.

Typical applications:

- Oil & Gas Industry
- Chemical and pharmaceutical industries
- Food processing (distillery)
- Printing & Plastic Industry
- Energy (Generation of Bio gas, gas turbines)
- Automotive industry (Paint finish)
- Waste processing plants

How to proceed when projecting a ATEX Cylinder

- Project an ETH - Electro Thrust Cylinder by means of this catalogue
- Check by means of the document "ETH ATEX frame conditions for applications" [192-550006] (order code position 9: "A" and position 12: "000") whether the selected ETH - Electro Thrust Cylinder corresponds to all ATEX demands in your application.
- In case the conditions cannot be fulfilled, please choose a larger electro cylinder and recheck the application data (e.g. changed cycle times).
- A application specific release by measuring the self-heating with your application data in our company is possible, please contact us. (see "ETH ATEX frame conditions for applications" [192-550006]).

Service Life

Nominal service life^{1,2}

The nominal service life of the electro cylinder can be determined with the aid of the diagrams page 14.

The forces calculated for each individual segment of the application cycle must be summarized into an equivalent axial force F_m "Calculating Required Axial Force" (page 11). If axial forces with different signs apply, two equivalent axial forces must be calculated:

- F_{m1} for all positive forces. The negative forces will convert to zero.
- F_{m2} for all negative forces. The positive forces will convert to zero.

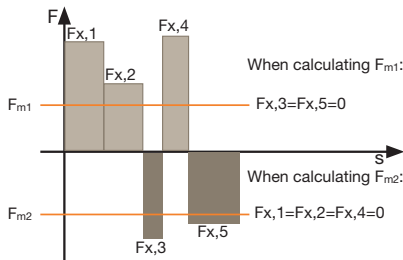

Calculation

$$F_{m1,2} = \sqrt[3]{\frac{1}{S_{total}} (F_{x,1}^3 \cdot s_1 + F_{x,2}^3 \cdot s_2 + F_{x,3}^3 \cdot s_3 + \dots)}$$

Formula 3

With the equivalent axial forces, the nominal service life L in km can be read off the diagrams on page 14.

With **load on both sides**, the nominal service life is:

$$L = (L_1^{-1.11} + L_2^{-1.11})^{-0.9}$$

Formula 3.1

Actual service life

The actual service life can only be approximated due to a variety of different effects. The nominal service life L calculation does, for instance, not take insufficient lubrication, impacts and vibrations or critical side loads into consideration. These effects can however be estimated with the aid of the application factor f_w .

The actual service life is calculated as follows:

$$L_{fw} = \frac{L}{f_w^3}$$

Formula 4

Application factor f_w

Movement cycle	Shocks/vibrations			
	none	light	medium	heavy
More than 2.5 screw rotations	1.0	1.2	1.4	1.7
1.0 to 2.5 screw rotations ³⁾ (short stroke applications)	1.8	2.1	2.5	3.0

³⁾After max. 10 000 movement cycles, a lubrication run must be performed (see lubrication run intervals for short stroke applications)

Boundary conditions for application factor f_w :

- Externally guided electro cylinders
- Accelerations $< 10 \text{ m/s}^2$

If your application factor is < 1.5 , please contact Parker.

The same applies for detailed calculations or for special boundary conditions.

Lubrication run lengths for short stroke applications

Lengths of lubrication runs [mm]	ETH032			ETH050			ETH080		ETH100		ETH125	
	M05	M10	M16	M05	M10	M20	M05	M10	M10	M20	M10	M20
>45	>54	>58	>40	>46	>58	>47	>65	>102	>140	>122	>210	

Abbreviations used (formula 3-4)

- F_m = Equivalent axial force in N
- $F_{x,j}$ = Resulting axial force in N (see formula 1 & formula 2, page 11)
- s_j = Travel given a defined force $F_{x,aj}$ in mm
- S_{total} = Total travel in mm
- L = Nominal service life in km (see "Service Life" diagrams page 14)
- L_{fw} = Service life respecting the application factor in km
- f_w = Application factor (see table "Application factor" page 13)

Index "j" for the individual segments of the application cycle

If you need the service life as the number of possible cycles, just divide the service life in kilometers by twice the stroke traveled. i.e. Standstill times are not taken into consideration when determining the equivalent axial force (F_m), as $s_j=0$. Caution, do always consider the stroke as well as the return stroke.

¹The nominal service life is the service life reached by 90 % of a sufficient number of similar electro cylinders until the first signs of material fatigue occur.

²ATEX cylinders feature a reduced the service life. Please note the brochure on "intended use" (192-550004).

Diagrams ²

The given values apply when adhering to the recommended lubrication intervals (see relubrication). The diagrams were established in accordance with DIN ISO 3408-5

ETH032

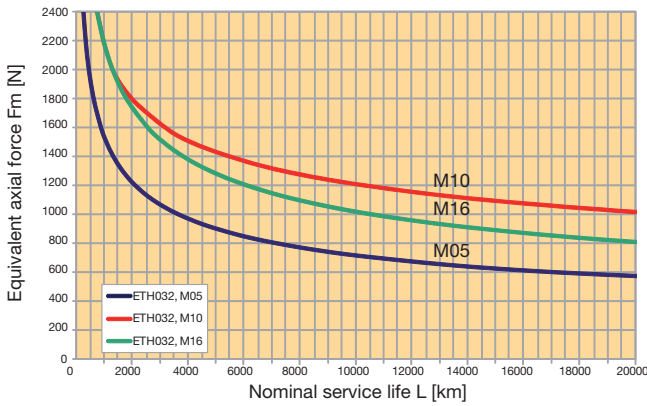

ETH050

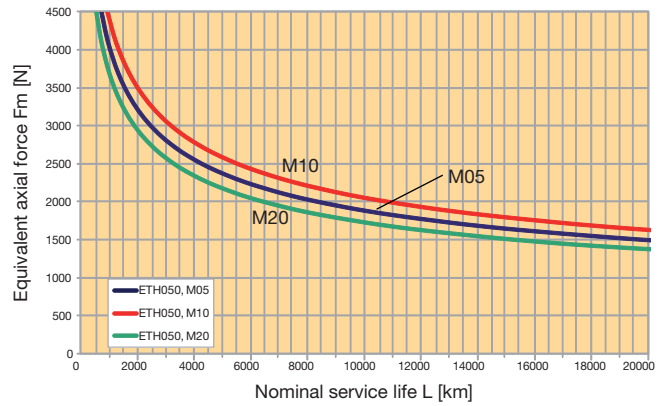

ETH080

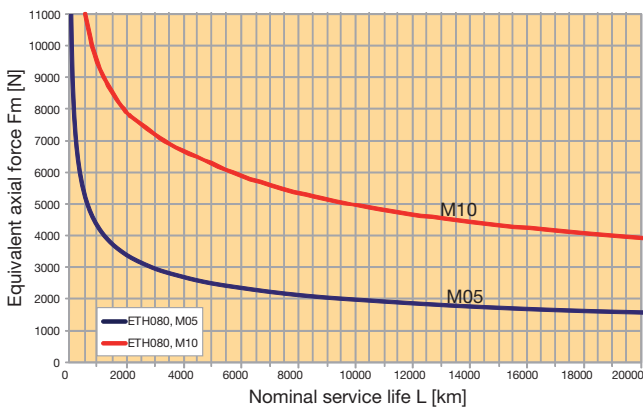

ETH100

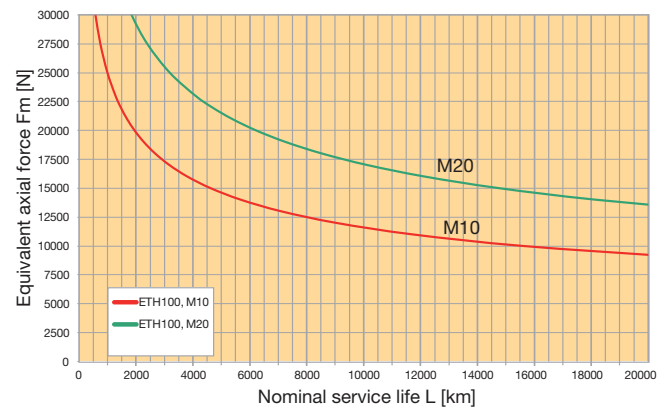

ETH125

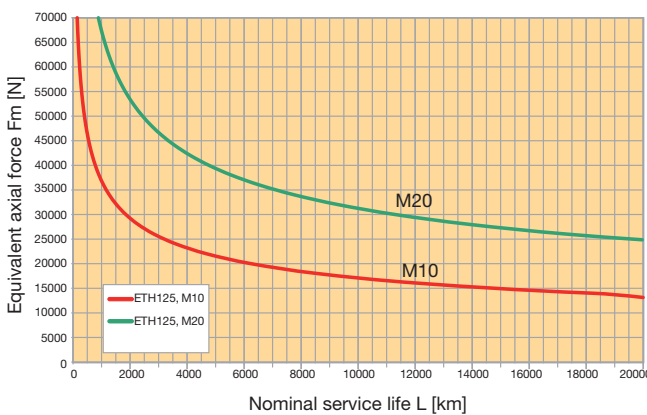

Prerequisites for nominal service life

- Bearing and screw temperature between 20 °C and 40 °C.
- No impairment of the lubrication, for example by external particles.
- Relubrication in accordance with the specifications.
- The given values for thrust force, speed and acceleration must be adhered to at any rate.
- No approaching the mechanical end stops (external or internal), no other abrupt loads, as the given maximum

- force of the cylinder may never be exceeded.
- No external side loads
- Application factor $f_w = 1$. In order to calculate the real service life and the corresponding application factor, please refer to chapter "Service Life" see page 13
- No high exploitation of several power features at a time (for example maximum speed or thrust force).
- No regulating oscillation at standstill.

²ATEX cylinders feature a reduced the service life. Please note the brochure on "intended use" (192-550004).

Permissible Torque with motor in parallel

The transmittable torque with parallel motor mounting is restricted by the belt transmission depending on the motor speed¹⁾ or on the screw pitch selected.

Conversion

The conversion from transmittable torque to the resulting axial tensile force / compressive force to the axial speed can be calculated using formulas 9 and 10.

$$F_{x,j} = M_{\text{motor}} \cdot \text{Force constant} \quad \text{Formula 9}$$

$$v_{\text{ETH}} = \frac{n_{\text{motor}}}{60} \cdot P_{\text{ETH}} \quad \text{Formula 10}$$

Abbreviations used (formula 9-10)

- $F_{x,j}$ = Axial tensile force / compressive force
 - P_{ETH} = Lead screw pitch in mm
 - v_{ETH} = Travel speed in mm / s
 - M_{motor} = Motor torque in Nm
 - n_{motor} = Motor speed in min^{-1}
- Force constant: Force constant, parallel motor mounting N/Nm (Technical data; page 8, 9)

Diagrams

ETH032

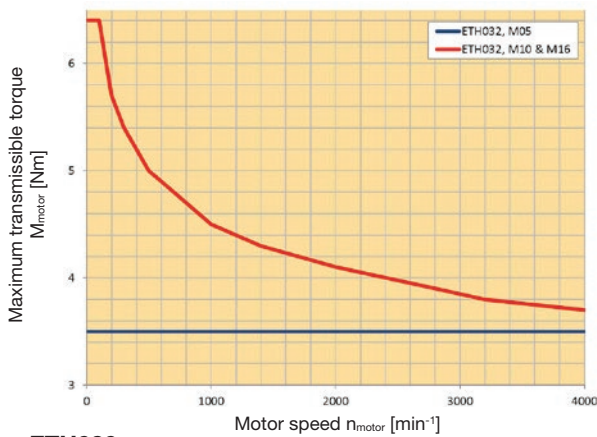

ETH050

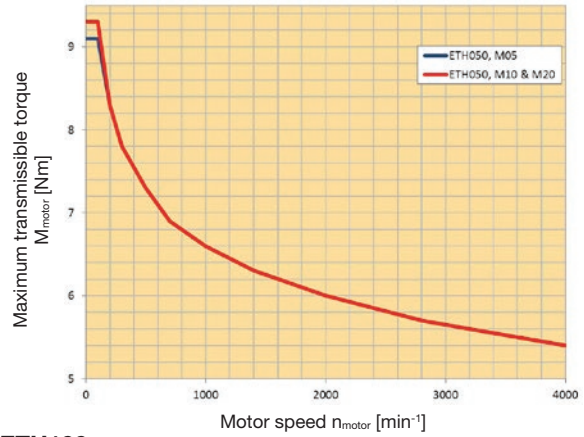

ETH080

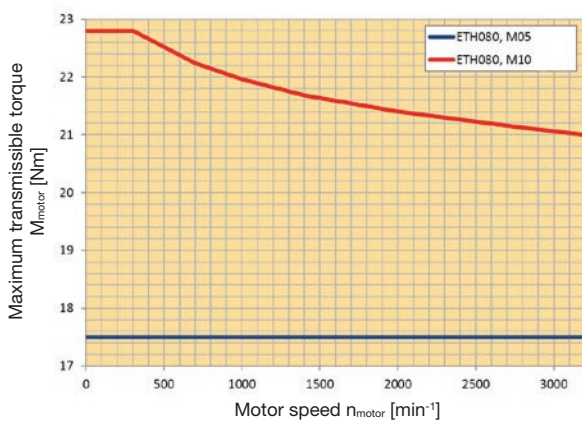

ETH100

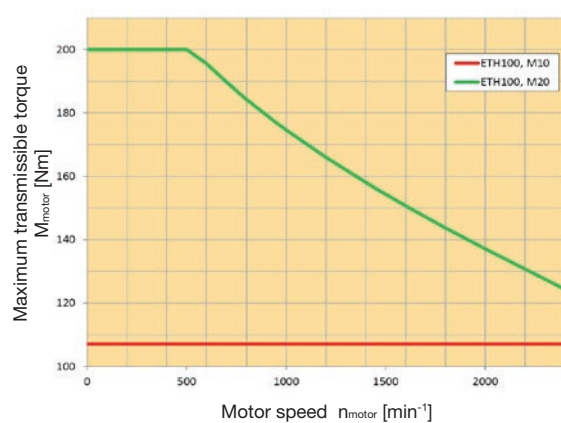

ETH125

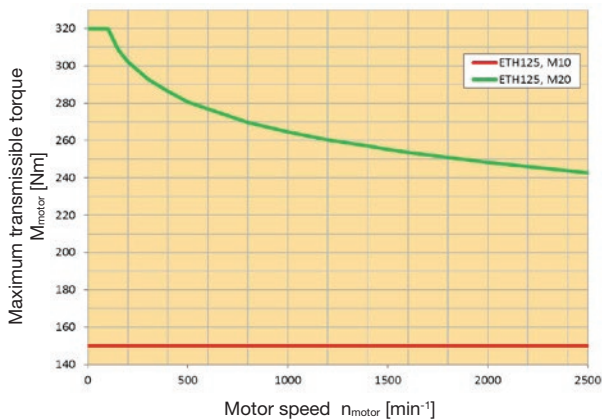

¹⁾ Please observe the maximum permitted, stroke-dependent speed of the cylinder selected (page 8, 9).

Permissible Axial Thrust Forces

Limited by the risk of buckling, depending on the stroke and the mounting method; traction forces do not pose any buckling risk.

Please check if the maximum axial force ((page 11)) is possible with the planned mounting method and for the desired stroke

Diagrams

Case 1

Cylinders fixed with mounting flanges, foot mounting or mounting plates.
Cylinder always fixed at the front end as well.
Thrust rod with axial guiding.

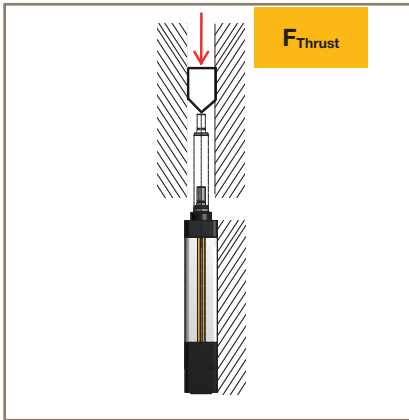

Case 2

Cylinders fixed with mounting flanges, foot mounting or mounting plates.
Cylinder always fixed at the front end as well.
Thrust rod without axial guiding. External force applied axially with respect to cylinder axis.

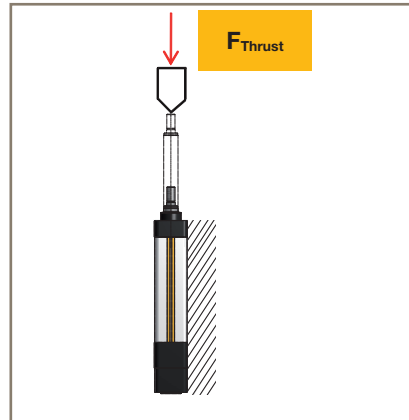

Case 3

Cylinder mounted with center trunnion, rear clevis or any other rear fixing material (e.g. rear mounting plate).
Thrust rod with axial guiding.

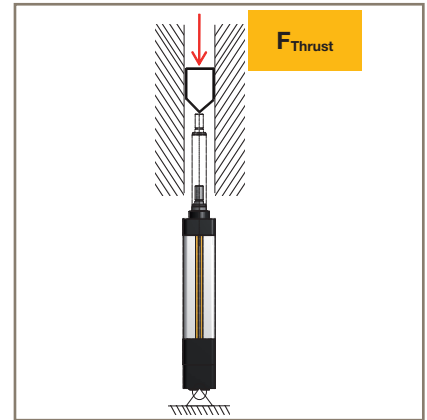

ETH032 - Case 1

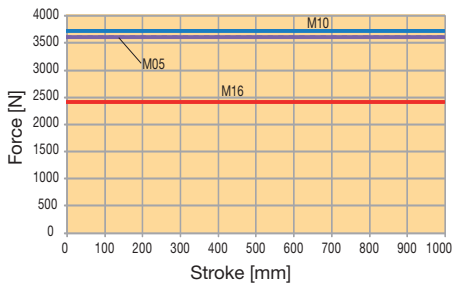

ETH032 - Case 2

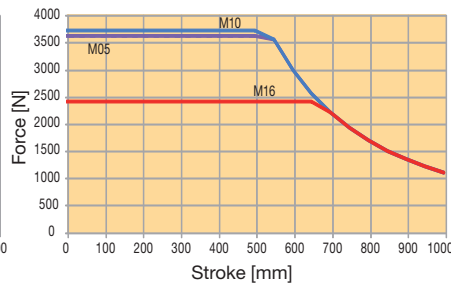

ETH032 - Case 3

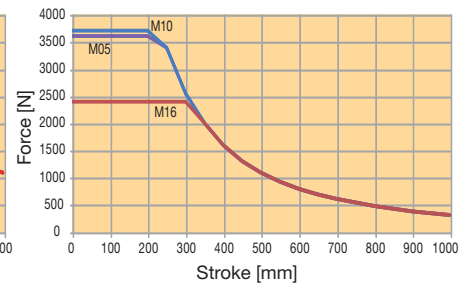

ETH050 - Case 1

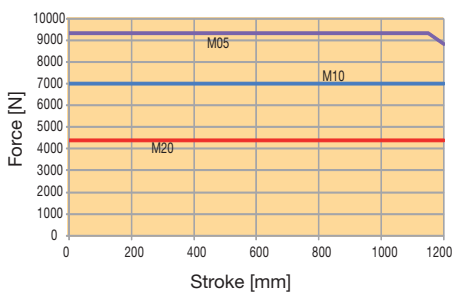

ETH050 - Case 2

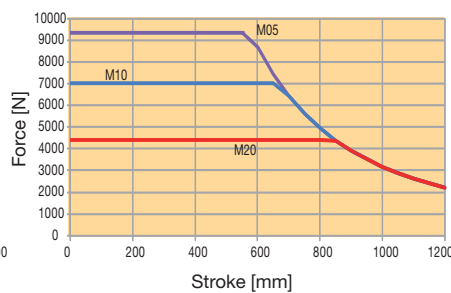

ETH050 - Case 3

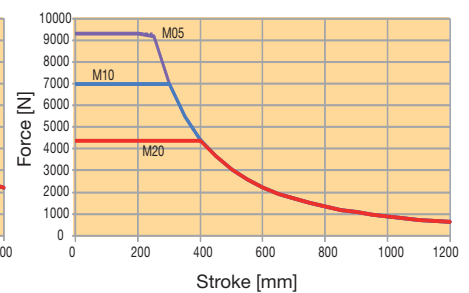

Case 1

Cylinders fixed with mounting flanges, foot mounting or mounting plates. Cylinder always fixed at the front end as well. Thrust rod with axial guiding.

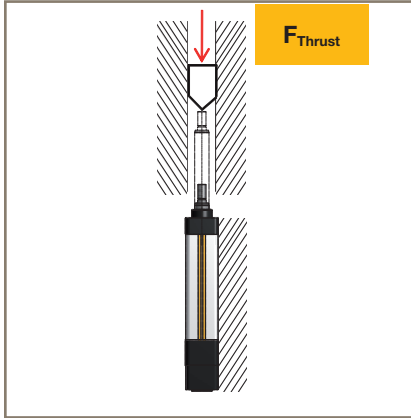

Case 2

Cylinders fixed with mounting flanges, foot mounting or mounting plates. Cylinder always fixed at the front end as well. Thrust rod without axial guiding. External force applied axially with respect to cylinder axis.

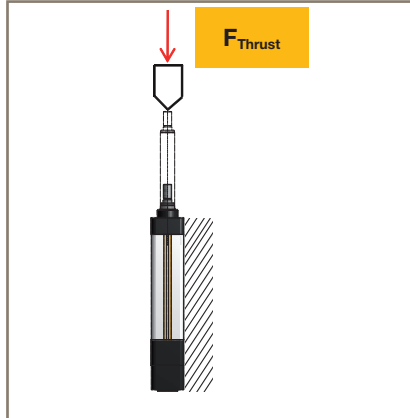

Case 3

Cylinder mounted with center trunnion, rear clevis or any other rear fixing material (e.g. rear mounting plate). Thrust rod with axial guiding.

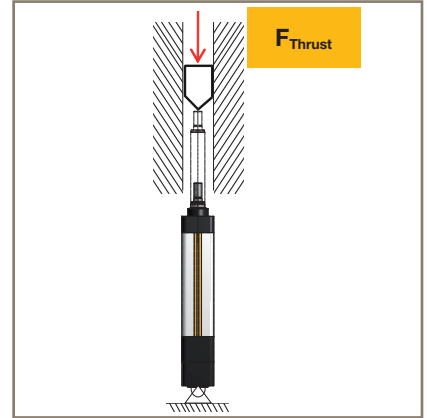

ETH080 - Case 1

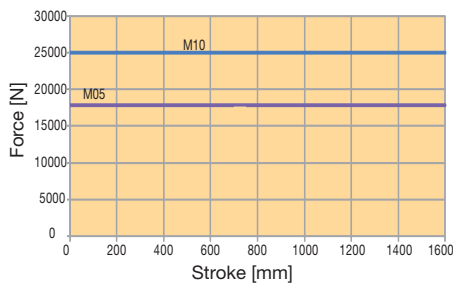

ETH080 - Case 2

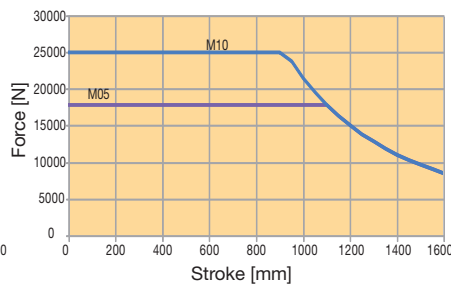

ETH080 - Case 3

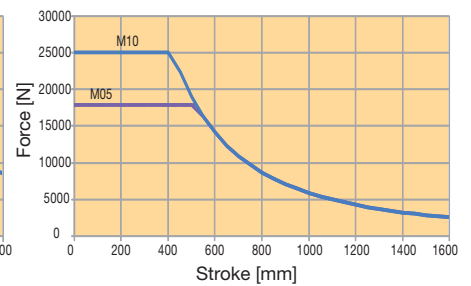

ETH100 - Case 1

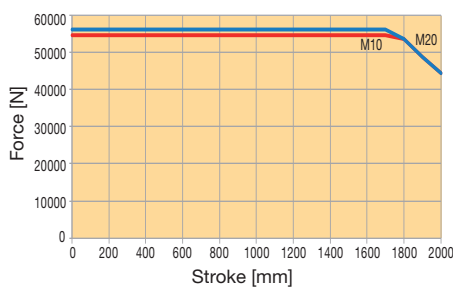

ETH100 - Case 2

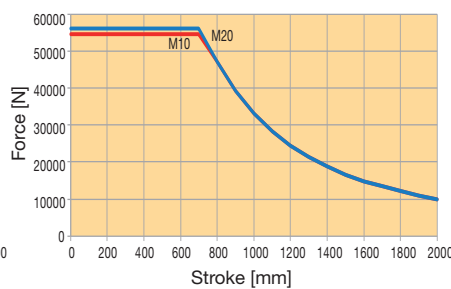

ETH100 - Case 3

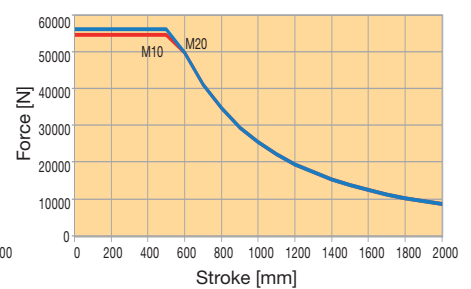

ETH125 - Case 1

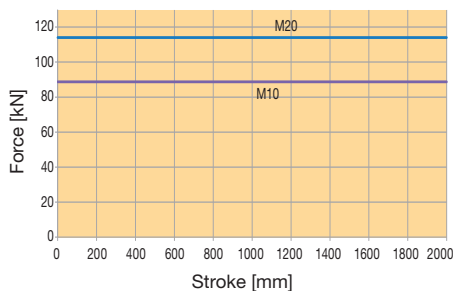

ETH125 - Case 2

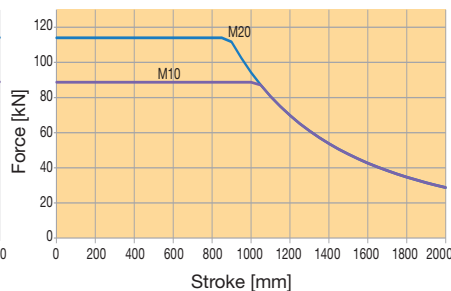

ETH125 - Case 3

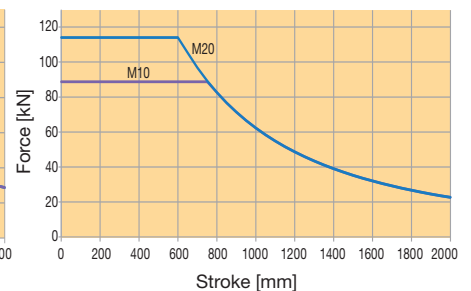

Permissible Side Load ¹⁾

The electro cylinder features a generously dimensioned cylinder rod and screw nut bearing in the form of high-quality plastic sliding elements to absorb the side load. Please note that electro cylinders with a longer stroke permit a higher lateral force at the same extension length. It may therefore be useful to choose a longer stroke

Permissible lateral forces in vertical mounting position

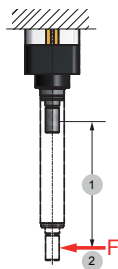

than required for the application in order to increase the permissible lateral force.

If the permissible lateral forces are exceeded or if the maximum axial force occurs at the same time, the optional outrigger bearing (option R) must be used.

Permissible lateral forces in horizontal mounting position



1: Extended length
2: Force application - at the middle of the cylinder rod thread

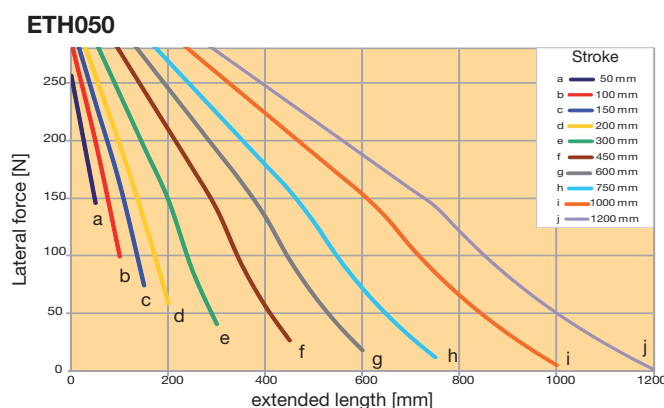
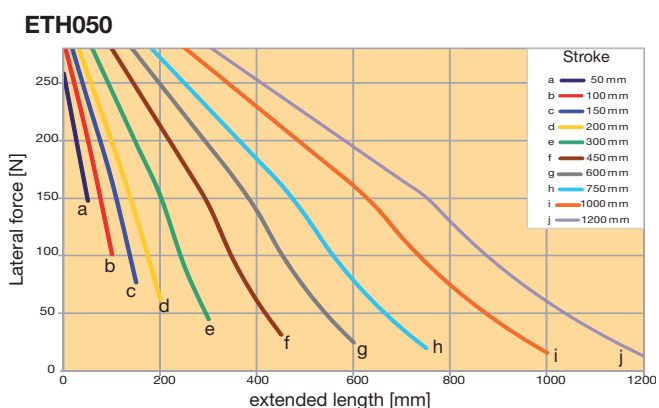
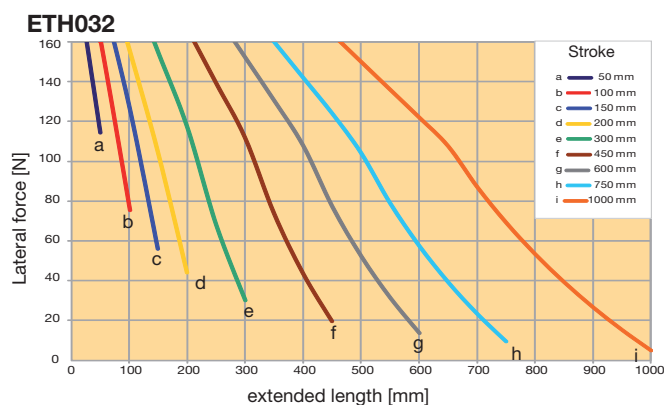
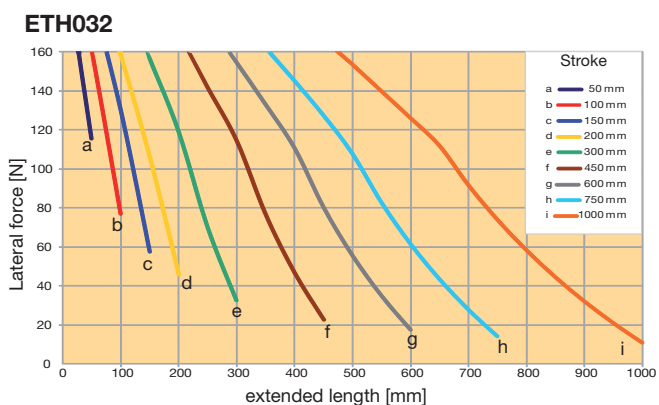

The diagrams apply for an ambient temperature of 20 °C, for all housing orientations and a medium travel speed of 0.5 m/s, (ETH032, ETH050, ETH080) or 0.25 m/s (ETH100, ETH125).

¹⁾ For ATEX cylinders, side loads are not permitted!

Permissible lateral forces in vertical mounting position

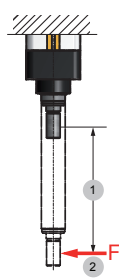

Permissible lateral forces in horizontal mounting position

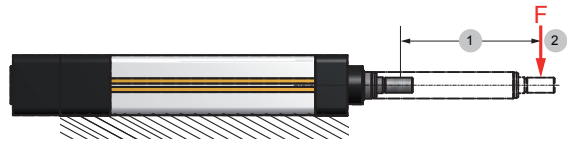

1: Extended length
2: Force application - at the middle of the cylinder rod thread

ETH080

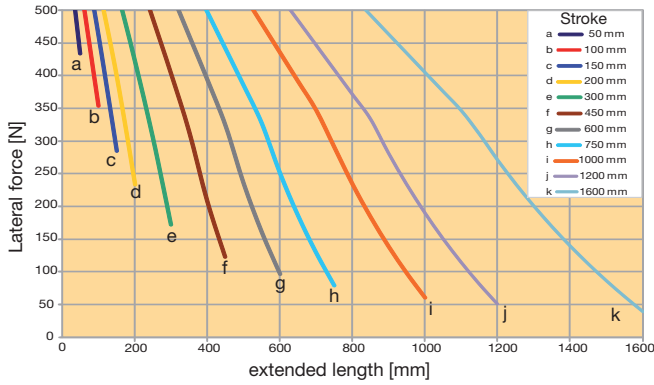

ETH080

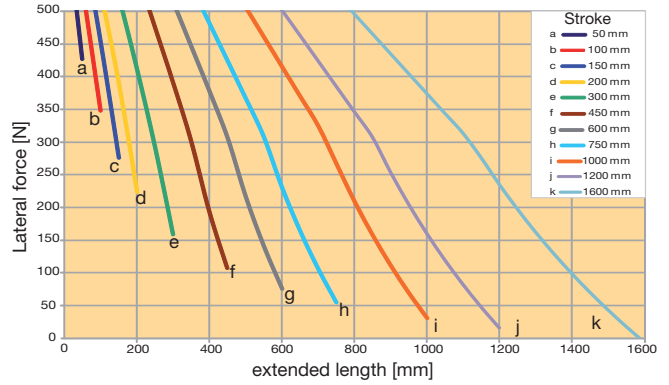

ETH100

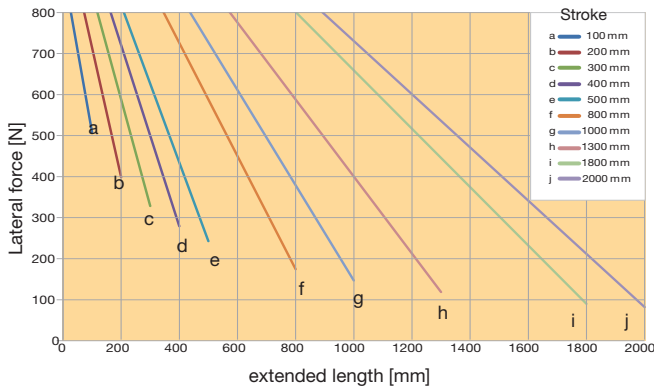

ETH100

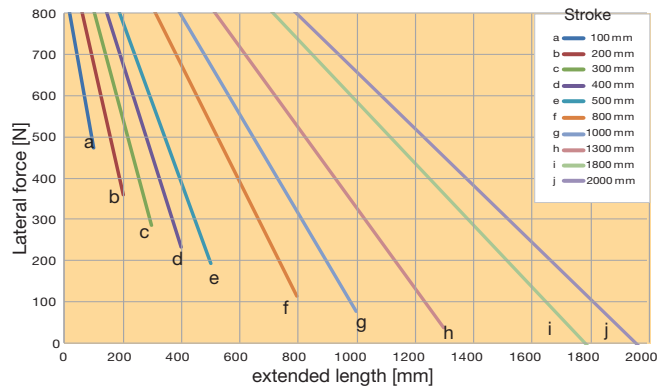

ETH125

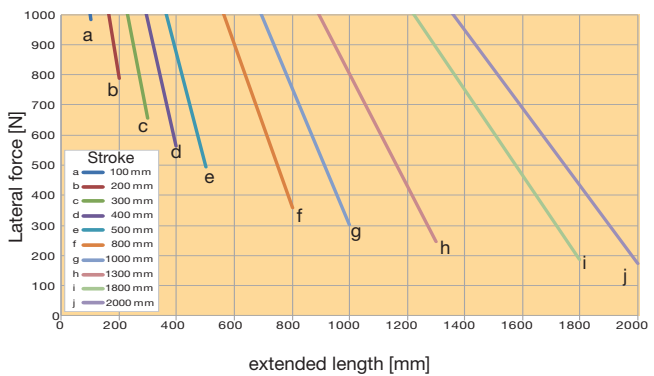

ETH125

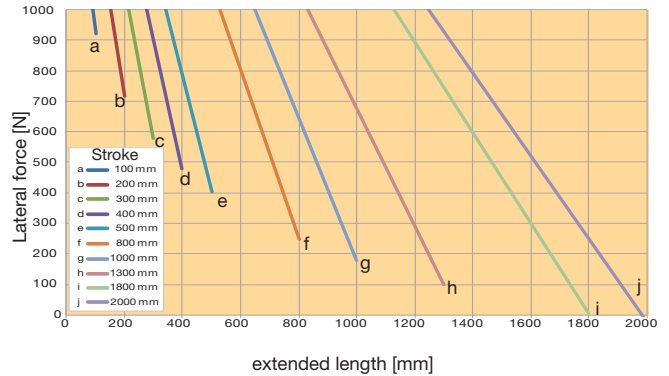

The diagrams apply for an ambient temperature of 20 °C, for all housing orientations and a medium travel speed of 0.5 m/s, (ETH032, ETH050, ETH080) or 0.25 m/s (ETH100, ETH125).

1) For ATEX cylinders, side loads are not permitted!

Stroke, Usable Stroke and Safety Travel

Calculation

Stroke:

The stroke to be indicated in the order code is the mechanically maximal possible stroke between the internal end stops.

Usable stroke:

The usable stroke is the distance which you need to move in your application. It is always shorter than the stroke.

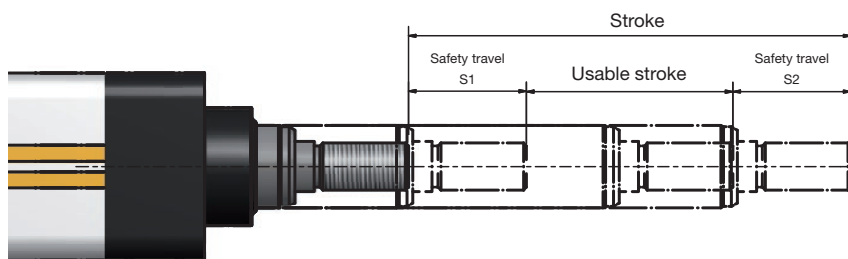

Safety travel (S1 & S2):

The safety travels are required to slow down the cylinder after it has passed a limit switch, Emergency stop in order to avoid contact with the mechanical limit stops.

Depending on the screw lead and the maximum speed, the following diagram recommends a minimum

safety travel, which is sufficient for most applications according to experience.

With demanding applications (great masses and high dynamic), the safety travel has to be calculated and enlarged accordingly (dimensioning on demand).

Diagram

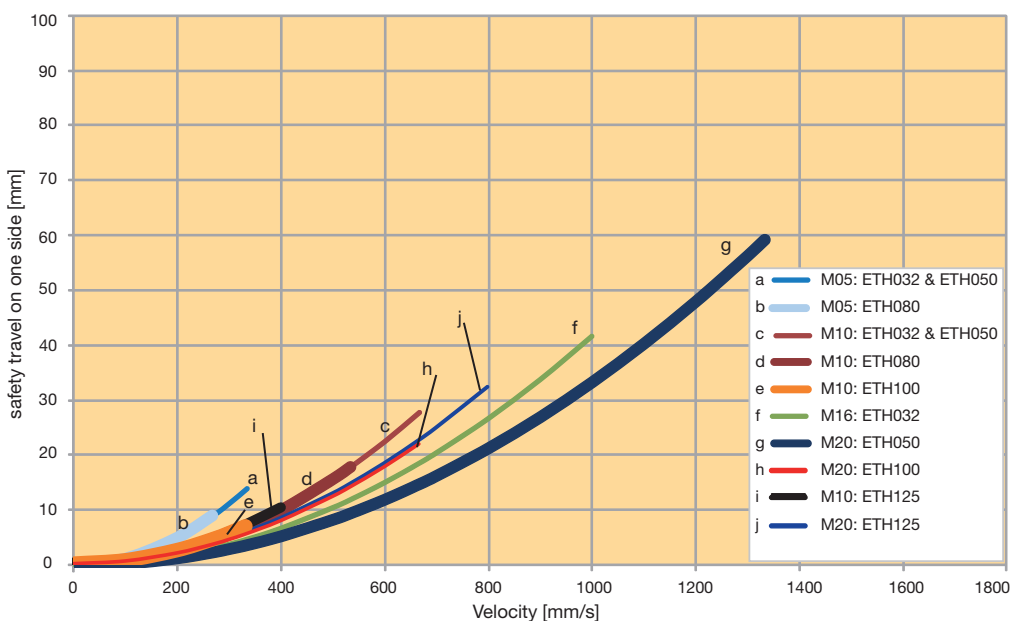

Information: The safety travel taken from the diagram applies for one side. I.e. the diagram value must be multiplied by factor 2 in order to get the total safety travel. The diagram is based on the maximum screw acceleration / deceleration

Relubrication

All frame sizes include a standard Easy lubrication port for lubricating the screw nut (designation "1" in the order code page 52).

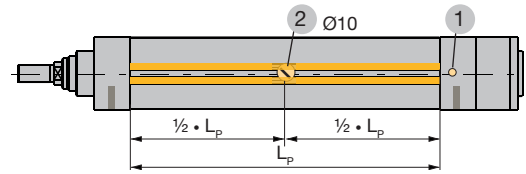

- 1: Central lubrication (standard)
- 2: Optional lubrication (possible on all 4 sides).
- L_p : Length of profile

Option 1: Central lubrication (standard)

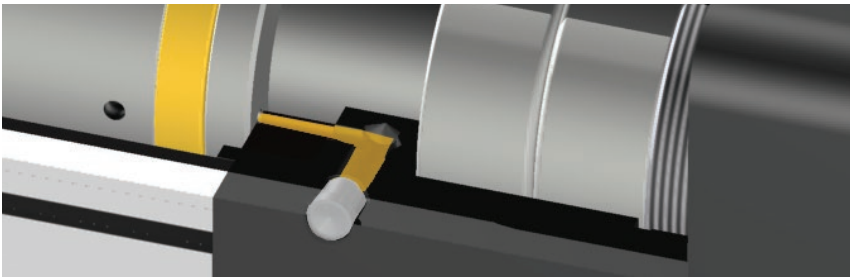

Relubrication is simple using the easy access port. Users simply perform a controlled retract of the cylinder approaching the end stop under slow speed and grease the cylinder. Central relubrication orientation is always envisaged in a 3 o'clock position.

Option 2...5: Middle lubrication via an opening in the profile

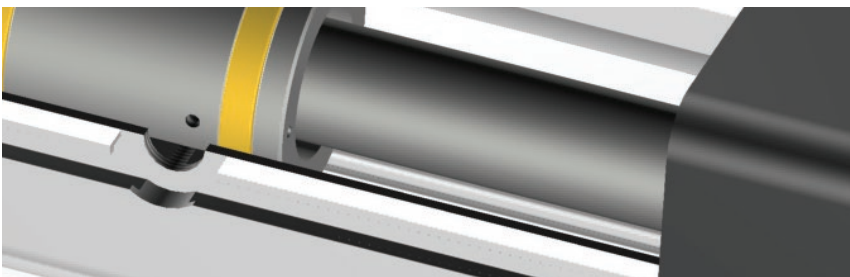

If a space constraint does not allow easy access to the standard lubrication port, other options are available.

Free access to this bore, even after integration of the cylinder into a system, can be ensured by choosing the corresponding profile orientation (see order code page 52). The bore is located in the middle of the aluminum profile.

In case of actuators with very short strokes, the position of the lubrication port in the center of the profile may not be possible. In this case, the relubrication position is located centrally in the stroke range. For more information see mounting instructions manual. (www.parker.com/eme/eth)

Use a suitable pipe for the funnel type lubricating nipple, Type D1a4 DIN3405:Beaked nozzle Item No.: 180-006043 (connection thread 1/8 ")

Dimensions

Electro Cylinder

prepared for inline motor mounting

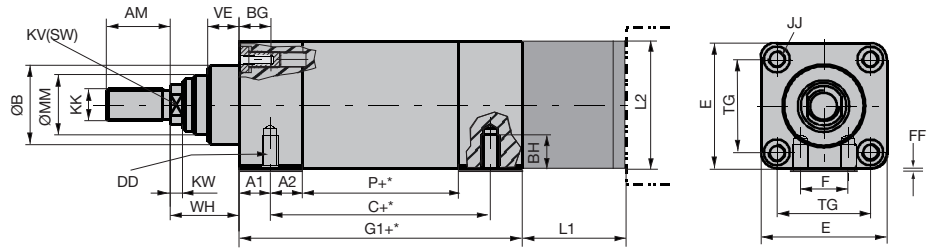

Electro Cylinder

prepared for parallel motor mounting

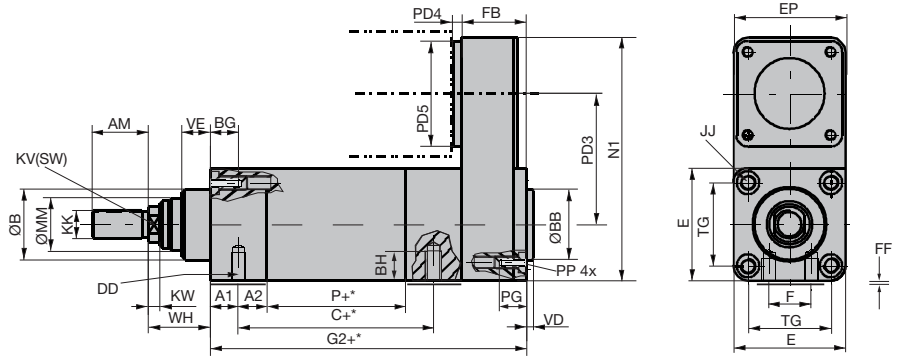

+* = Measure + length of desired stroke

Dimensions Standard & ATEX (IP-Version)

Cylinder size	Unit	ETH032			ETH050			ETH080		ETH100		ETH125	
		M05	M10	M16	M05	M10	M20	M05	M10	M10	M20	M10	M20
Screw lead													
C	[mm]	93.6 (93.6)	102.6 (102.6)	106.6 (106.6)	99.5 (100.5)	105.5 (106.5)	117.5 (118.5)	141.5 (142.5)	159.5 (160.5)	- 2)		- 2)	
G1	[mm]	133 (180.5)	142 (189.5)	146 (193.5)	154 (198.5)	160 (204.5)	172 (216.5)	197 (259.5)	215 (277.5)	323 (349.5)	361 (387.5)	461 (487.5)	549 (575.5)
G2	[mm]	180.5 (228.5)	189.5 (237.5)	193.5 (241.5)	194 (239)	200 (245)	212 (257)	257 (320)	275 (338)	451 (478.0)	489 (516.0)	624 (651.0)	712 (739.0)
P	[mm]	66	75	79	67	73	85	89	107	162	200	192	280
A1	[mm]	14 (60)			15.5 (58.5)			21 (82)		- 2)		- 2)	
A2	[mm]	17			18.5			32		- 2)		- 2)	
AM	[mm]	22			32			40		70		96	
BG (=BN+BS)	[mm]	16			25			26		32		44	
BN Usable length of thread	[mm]	11			20			20		22		33	
BS Depth of width across flat (without thread)	[mm]	5			5			6		10		11	
BH	[mm]	9			12.7			18.5		- 2)		- 2)	
DD mount thread 1)	[mm]	M6x1.0			M8x1.25			M12x1.75		- 2)		- 2)	
E	[mm]	46.5			63.5			95		120		150	
EP	[mm]	46.5			63.5			95		175		220	
F	[mm]	16			24			30		- 2)		- 2)	
FF	[mm]	0.5			0.5			1.0		0		0	
JJ	[mm]	M6x1.0			M8x1.25			M10x1.5		M16x2		M20x2.5	
PP	[mm]	M6x1.0			M8x1.25			M10x1.5		M16x2		M20x2.5	
PG (Thread depth on the PA housing)	[mm]	BG (=BN+BS)			BG (=BN+BS)			BG (=BN+BS)		26		35	
KK	[mm]	M10x1.25			M16x1.5			M20x1.5		M42x2		M48x2	
KV	[mm]	10			17			22		46		55	
ØMM h9	[mm]	22			28			45		70		85	
TG	[mm]	32.5			46.5			72		89		105	
KW	[mm]	5			6.5			10		10		10	
N1	[mm]	126			160			233.5		347		450	
FB	[mm]	47.5 (48)			40 (40.5)			60 (60.5)		128 (128.5)		163 (163.5)	
VD	[mm]	4			4			4		4		5	
ØBB	[mm]	30 d11			40 d11			45 d11		90 d9		110 d8	
VE	[mm]	12			16			20		20		20	
WH	[mm]	26			37			46		51		53	
ØB	[mm]	30 d11			40 d11			60 d11		90 d8		110 d8	

1) Thread "DD" is only mandatory for mounting method "F".

2) ETH100, ETH125 does not have a mounting thread on the underside.

Motor Mounting Options ¹⁾

ETH032	inline	Code	Motor / gearbox	Motor Dimensions			Motor mounting options			
				Pilot	Bolt circle	∅ Shaft	Shaft length	L1	L2	
	K1B	SMH60-B5/11	60	75	11	23	60.0	70.0		
	K1B	NX3, EX3	60	75	11	23	60.0	70.0		
	K1C	SMH82-B8/14	80	100	14	30	67.0	82.0		
	P1A	--	50	70	16	40	77.0	63.5		
	P1G	PE3	40	52	14	35	72.0	63.5		
	parallel	Code	Motor / gearbox	Pilot	Bolt circle	∅ Shaft	Shaft length	PD3	PD4	PD5
		K1B	SMH60-B5/11	60	75	11	23	67.5	9.0	70.0
		K1B	NX3	60	75	11	23		9.0	70.0
		K1B	EX3	60	75	11	23		72.5	70.0
		K1C	SMH82-B8/14	80	100	14	30		14.0	82.0
		P1A	--	50	70	16	40		22.0	63.5
		P1G	PE3	40	52	14	35		16.0	63.5

ETH050	inline	Code	Motor / gearbox	Motor dimensions			Motor mounting options		
				Pilot	Bolt circle	∅ Shaft	Shaft length	L1	L2
	K1B	SMH60-B5/11	60	75	11	23	59	70	
	K1B	NX3	60	75	11	23	59	70	
	K1C	SMH82-B8/14	80	100	14	30	63	82	
	K1E	SMH82-B5/19	95	115	19	40	84	100	
	K1E	SMH100-B5/19	95	115	19	40	84	100	
	K1E	MH105-B5/19	95	115	19	40	84	105	
	K1D	MH105-B9/19	80	100	19	40	84	105	
	K1D	SMH82-B8/19	80	100	19	40	84	82	
	K1D	NX4, EX4	80	100	19	40	84	82	
	P1A	--	50	70	16	40	74	63.5	
	P1G	PE3	40	52	14	35	69	63.5	
	parallel	Code	Motor / gearbox	Pilot	Bolt circle	∅ Shaft	Shaft length	PD3	PD4
	K1B	SMH60-B5/11	60	75	11	23	87.5	9	70
	K1B	NX3	60	75	11	23		9	70
	K1C	SMH82-B8/14	80	100	14	30		13	82
	K1D	EX4	80	100	19	40		92	92
	K1F	SMH100-B5/14 ²⁾	95	115	14	30		13	100
	P1A	--	50	70	16	40		24	63.5
	P1G	PE3	40	52	14	35		16	63.5

¹⁾ For ETH ATEX version use only ATEX certified motors/gearboxes (e.g. EX motor series)

²⁾ Order Code SMH100-B5/14: " SMH100...ET..." (the motor shaft diameter is replaced by the term "ET")

(not in the motors catalog) only with feedback: Resolver, A7

ETH032/ETH050/ETH080: Motors always with key groove on the output shaft.

Additional motor mounting options on request.

Before mounting a motor not listed above, please consult the Parker support team at em-motion@parker.com.

Details on the Internet:

Motors

www.parker.com/eme/smh, www.parker.com/eme/mh
www.parker.com/eme/nx, www.parker.com/eme/ex

Gearboxes

www.parker.com/eme/gear

		Code	Motor / gearbox	Motor Dimensions			Motor mounting options				
				Pilot	Bolt circle	∅ Shaft	Shaft length	L1	L2		
ETH080	inline										
		K1E	SMH82-B5/19	95	115	19	40	94.5	100		
		K1E	SMH100-B5/19	95	115	19	40	94.5	100		
		K1E	MH105-B5/19	95	115	19	40	94.5	100		
		K1D	MH105-B9/19	80	100	19	40	94.5	96		
		K1D	SMH82-B8/19	80	100	19	40	94.5	96		
		K1D	NX4	80	100	19	40	94.5	96		
		K1K	MH145-B5/24	130	165	24	50	104.5	145		
		K1K	SMH142-B5/24	130	165	24	50	104.5	145		
		K1J	MH105-B6/24	110	130	24	50	104.5	116		
		K1J	SMH115-B7/24	110	130	24	50	104.5	116		
		K1J	NX6, EX6	110	130	24	50	104.5	116		
		P1B	--	80	100	22	52	106.5	95		
		P1H	PE4	80	100	20	40	94.5	95		
		parallel									
			K1E	SMH82-B5/19	95	115	19	40	130	15	100
			K1E	SMH100-B5/19	95	115	19	40		15	100
			K1E	MH105-B5/19	95	115	19	40		15	100
			K1D	MH105-B9/19	80	100	19	40		15	96
			K1D	SMH82-B8/19	80	100	19	40		15	96
			K1D	NX4	80	100	19	40		15	96
			K1K	MH145-B5/24	130	165	24	50		15	145
			K1K	SMH142-B5/24	130	165	24	50		15	145
		K1J	MH105-B6/24	110	130	24	50	15		116	
		K1J	SMH115-B7/24	110	130	24	50	15		116	
		K1J	NX6	110	130	24	50	15		116	
		K1J	EX6	110	130	24	50	121.5		120	
		P1B	--	80	100	22	52	30		95	
		P1H	PE4	80	100	20	40	12		95	

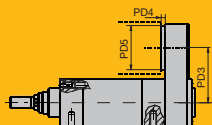
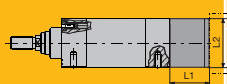

ETH032/ETH050/ETH080: Motors always with key groove on the output shaft.

Additional motor mounting options on request.

Before mounting a motor not listed above, please consult the Parker support team at em-motion@parker.com.

Details on the Internet:

Motors

- www.parker.com/eme/smh
- www.parker.com/eme/mh
- www.parker.com/eme/nx
- www.parker.com/eme/ex

Gearboxes

- www.parker.com/eme/gear

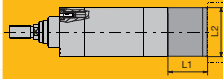
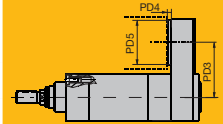
			Motor Dimensions				Motor mounting options			
			Pilot	Bolt circle	∅ Shaft	Shaft length	L1	L2		
ETH100	inline	Code	Motor / gearbox	Pilot	Bolt circle	∅ Shaft	Shaft length	L1	L2	
		K1J	SMH115-B7/24, NX6, EX6	110	130	24	50	155	140	
		K1K	SMH142-B5/24	130	165	24	50	155	145	
		K1K	MH145-B5/24	130	165	24	50	155	145	
		K1L	MH205-B5/38	180	215	38	80	185	205	
		K1L	SMH170-B5/38	180	215	38	80	185	205	
		P1C	--	110	130	32	68	175	140	
		P1D	--	130	165	40	102	207	142	
		P1J	PE5	110	130	25	55	160	140	
	parallel	Code	Motor / gearbox	Pilot	Bolt circle	∅ Shaft	Shaft length	PD3	PD4	PD5
		K1J	SMH115-B7/24, NX6, EX6	110	130	24	50		23	155
		K1K	SMH142-B5/24	130	165	24	50		22	155
		K1K	MH145-B5/24	130	165	24	50		22	155
		K1L	MH205-B5/38	180	215	38	80		27	205
K1L		SMH170-B5/38	180	215	38	80		27	205	
P1C		--	110	130	32	68		38	155	
P1D		--	130	165	40	102		45	155	
P1J		PE5	110	130	25	55		23	155	

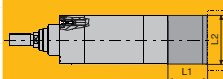
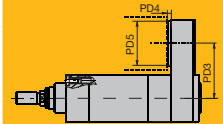
			Motor Dimensions				Motor mounting options			
			Pilot	Bolt circle	∅ Shaft	Shaft length	L1	L2		
ETH125	inline	Code	Motor / gearbox	Pilot	Bolt circle	∅ Shaft	Shaft length	L1	L2	
		K1L	SMH170	180	215	38	80	209.5	205	
		K1L	MH205	180	215	38	80	209.5	205	
		K1M	MH265	250	300	48	110	239.5	264	
		P1C	--	110	130	32	68	197.5	170	
		P1D	--	130	165	40	102	231.5	170	
		P1K	PE7	120	140	40	97	226.5	205	
		parallel	Code	Motor / gearbox	Pilot	Bolt circle	∅ Shaft	Shaft length	PD3	PD4
		K1L	SMH170	180	215	38	80		25	205
		K1L	MH205	180	215	38	80		25	205
		K1M	MH265	250	300	48	110	224	45	264
		P1C	--	110	130	32	68		32	185
		P1D	--	130	165	40	102		45	185
		P1K	PE7	120	140	40	97		42	205

ETH100/ETH125: Motors always without key groove on the output shaft.

Additional motor mounting options on request.

Before mounting a motor not listed above, please consult the Parker support team at em-motion@parker.com.

Details on the Internet:

Motors

www.parker.com/eme/smh
www.parker.com/eme/mh
www.parker.com/eme/nx
www.parker.com/eme/ex

Gearboxes

www.parker.com/eme/gear

Motor and Gearbox Selection

Drive torque calculation

The torques to be produced by the motor result from the acceleration, the load and the friction torque. The drive torques must be calculated for all segments of the application cycle (represented by index "j")

Calculation of the **acceleration torque** with respect to the rotary moments of inertia:

$$M_{B,j} = \left((J_{i/p,0} + J_{i/p,Stroke} \cdot Stroke) \cdot \frac{1}{\eta_{ETH}} \cdot \frac{1}{i_G^2 \cdot \eta_G} + J_G + J_M \right) \cdot 10^{-3} \cdot \frac{6.28 \cdot a_{Kj}}{P_h}$$

only with gearbox

Formula 5

The acceleration forces due to the translatory moved masses are taken into consideration in the calculation of the axial forces on (page 11).

The **load torques** result from the occurring axial forces:

$$M_{L,j} = \frac{F_{x,a/ej}}{\text{Thrust force factor}} \cdot \frac{1}{i_G \cdot \eta_G}$$

only with gearbox

Formula 6

The motor must therefore generate the following drive torques:

$$M_{M,j} = M_{B,j} + M_{L,j}$$

Formula 7

The **effective torque** can be deduced from the drive torques for all segments of the application cycle (formula 7):

$$M_{eff} = \sqrt[2]{\frac{1}{t_{total}} \cdot (M_{M1}^2 \cdot t_1 + M_{M2}^2 \cdot t_2 + \dots)}$$

Formula 8

Motor dimensioning

- The nominal torque of the motor must exceed the calculated effective torque (formula 8).
- The peak torque of the motor must exceed the maximum occurring drive torque (formula 7).

With the aid of the "motor mounting options" chart you can check if the respective motor is mechanically compatible to the corresponding electro cylinder.

Abbreviations used (formula 5-8)

$M_{B,j}$	= Variable acceleration torque in Nm
$J_{i/p,0}$	= Red. rot. mass moment of inertia at zero stroke for inline/parallel motor configuration in kgmm ² see "Technical Data" page 8
$J_{i/p,Stroke}$	= Red. rot. mass moment of inertia per mm of stroke for inline/parallel motor configuration in kgmm ² see "Technical Data" page 8
Stroke	= Selected stroke in mm
η_{ETH}	= Efficiency of the electro cylinder 0.9 (inline drive configuration) 0.81 (parallel motor)
i_G	= Gearbox ratio
η_G	= Efficiency of the gearbox (see gearbox manufacturer specifications)
J_M	= Motor mass moment of inertia in kgmm ² /mm (see motor manufacturer specifications)
J_G	= Gearbox mass moment of inertia in kgmm ² /mm (see gearbox manufacturer specifications)
a_{Kj}	= Acceleration at the cylinder rod in m/s ²
P_h	= Screw pitch in mm
$M_{L,j}$	= Load torque in Nm
$F_{x,a/ej}$	= Loads in x direction in N (see page 11)
$M_{M,j}$	= Drive torque in Nm
M_{eff}	= Effective value - motor in Nm
t_{total}	= Total cycle time in s
t_j	= Amount of time in the cycle in s

Force constant: "Technical Characteristics" see page 8.
Index "j" for the individual segments of the application cycle

Mounting Methods

Please respect the notes in the ETH Manual (19x-550002) on the permissible screws and tightening torques.

Standard

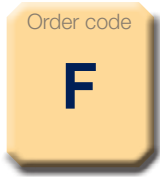

ETH032-ETH125

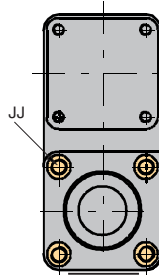

Example for parallel motor configuration

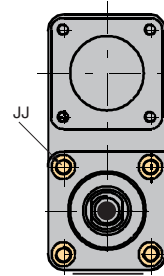

Mounting via thread on the cylinder front or end side with parallel motor configuration (ETH032-ETH125).
("Dimensions" see page 22)

ETH032-ETH080

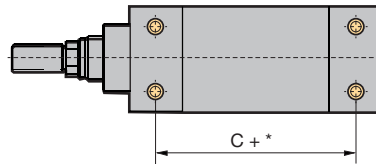

Mounting with 4 mounting threads on the underside of the profile. (ETH032-ETH080).
("Dimensions" see page 22)

Center Trunnion Mounting

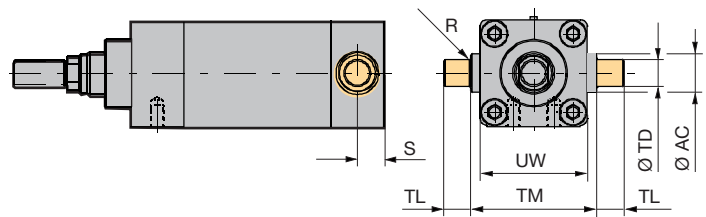
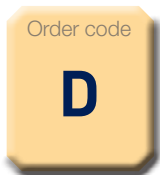

	UW	ØTD (h8)	R	TL	TM	ØAC	S
	[mm]	[mm]	[mm]	[mm]	[mm]	[mm]	[mm]
ETH032	46.5	12	1	12	50	18	25.5
ETH050	63.5	16	1	16	75	25	39
ETH080	95.3	25	2	25	110	35	34.5
ETH100	120	40	4	40	140	70	57
ETH125	150	50	10	52	160	90	100

+* = Measure + Length of desired stroke ("Dimensions" see page 22).

Note: For relubrication option "1" (central lubrication port) please see mounting method with option "D" center trunnion always on 6 o'clock!

Rear Clevis

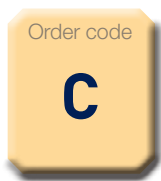

ETH032-ETH080

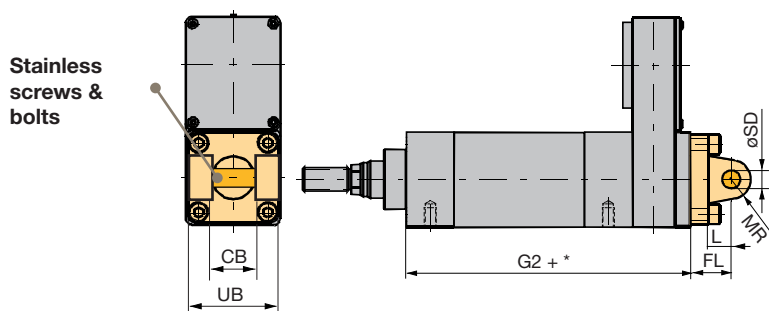

ETH100 & ETH125

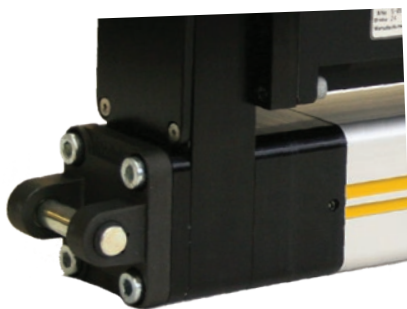
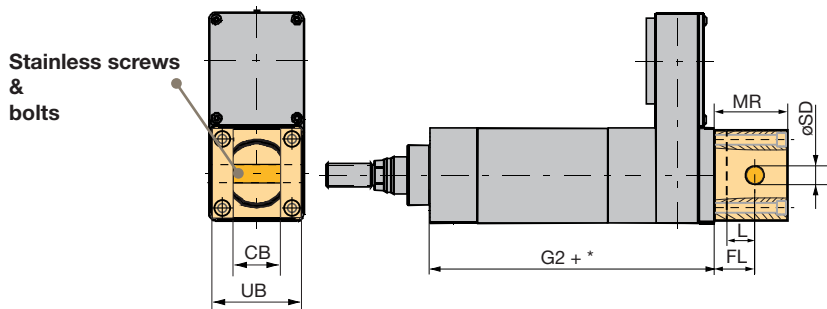

	Order no.	UB	CB	ØSD	MR	L	FL ±0.2
		[mm]	[mm]	[mm]	[mm]	[mm]	[mm]
ETH032	0112.031	46.5	26	10 h9	9.5	13	22
ETH050	0122.031	63.5	32	12 h9	12.5	16	27
ETH080	0132.031	95	50	16 h9	17.5	22	36
ETH100	0142.031	120	60.5	30 f7	100	40	65
ETH125	0152.031	150	70.5	50 f7	145	55	90

+* = Measure + length of desired stroke ("Dimensions" see page 22).
Listed in the order code of the cylinder; the order number applies only for ordering spare parts. Spare parts delivery is including screws for cylinder mounting.

Bearing Block

Counter piece of rear clevis. Please order separately with order no., if required

Dimensions [mm]

Bearing block for ETH032, Part No. 0112.039

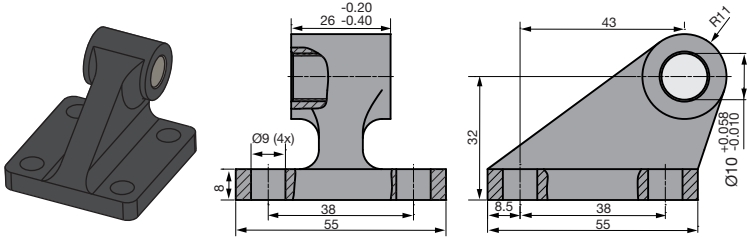

Bearing block for ETH050, Part No. 0122.039

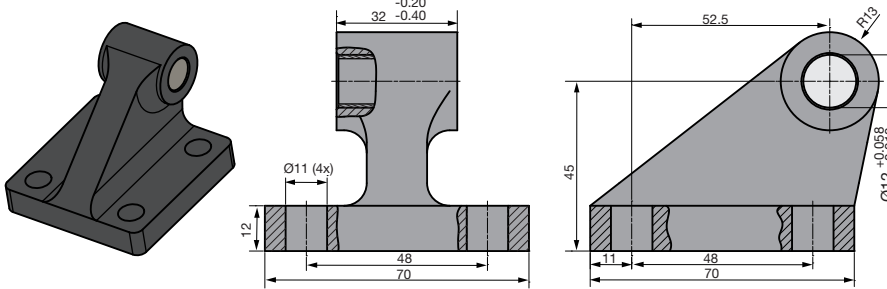

Bearing block for ETH080, Part No. 0132.039

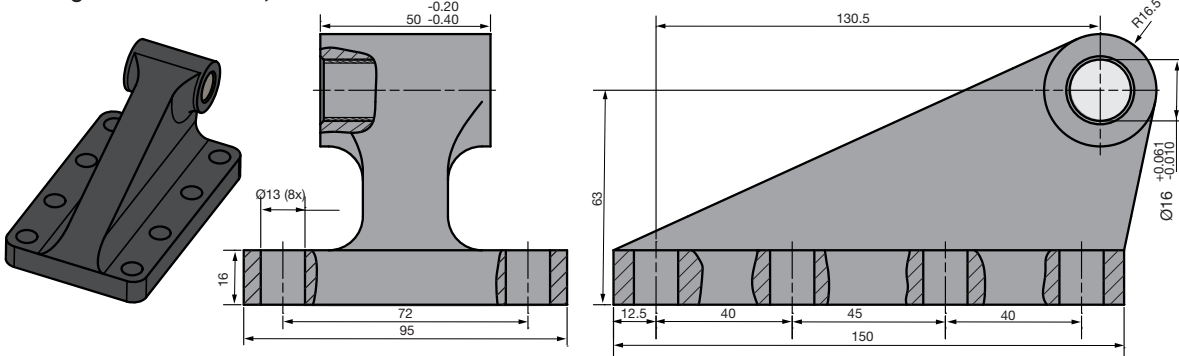

Bearing block for ETH100, Part No. 0142.039

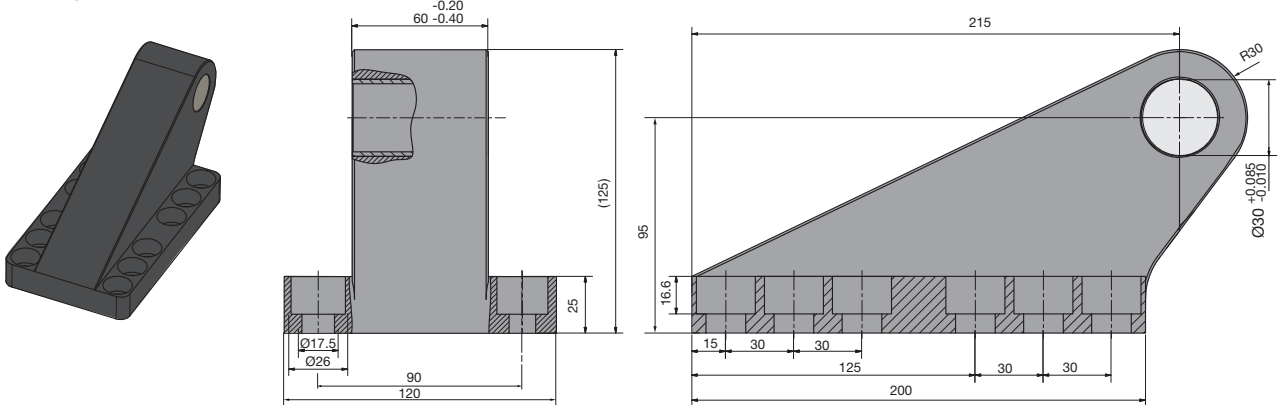

Bearing block for ETH125, Part No. 0152.039

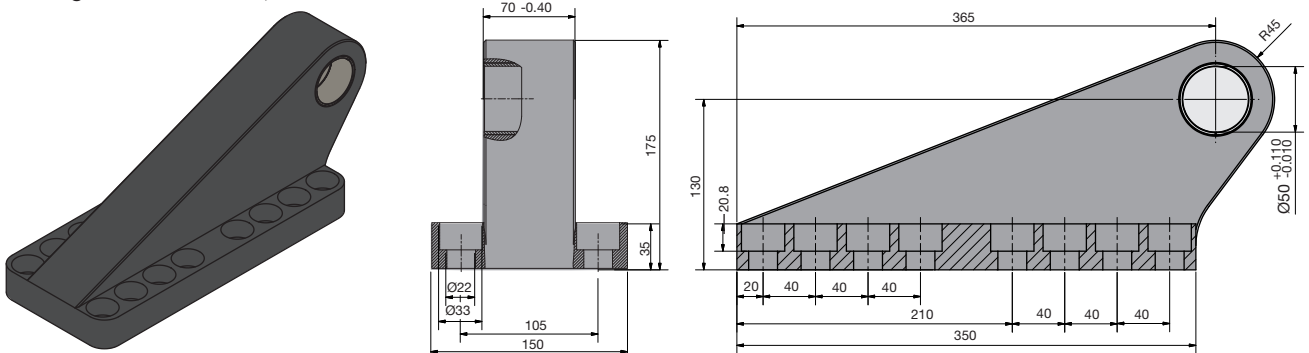

Front Plate

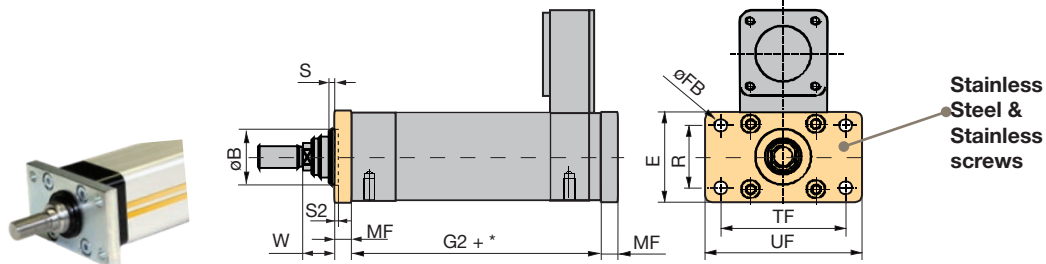
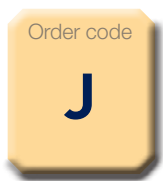

Front plate (J) dimensions

	Order no. (1 piece)	UF	E	TF	ØFB	R	W	MF	ØB Rear Plate	ØB Front plate	S	S2
		[mm]	[mm]	[mm]	[mm]	[mm]	[mm]	[mm]	[mm]	[mm]	[mm]	[mm]
ETH032	0112.918	80	48	64	7	32	16	10	30		2	-
ETH050	0122.918	110	65	90	9	45	25	12	40		4	-
ETH080	0132.919 ⁽¹⁾	150	95	126	12	63	30	16	45	60	4	-
ETH100	0142.918	258	120	220	17.5	80	26	25	90		-	5
ETH125	0152.918	320	150	270	21.5	100	13	40	110		-	20

+* = Measure + Length of desired stroke ("Dimensions" see page 22).

Listed in the order code of the cylinder; the order number applies only for ordering spare parts.

Spare parts delivery is including screws for cylinder mounting.

Stainless components only available for ETH032-ETH100.

⁽¹⁾ Note: This plate is not useable as rear plate

Foot Mounting

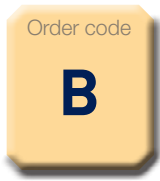

ETH032-ETH080

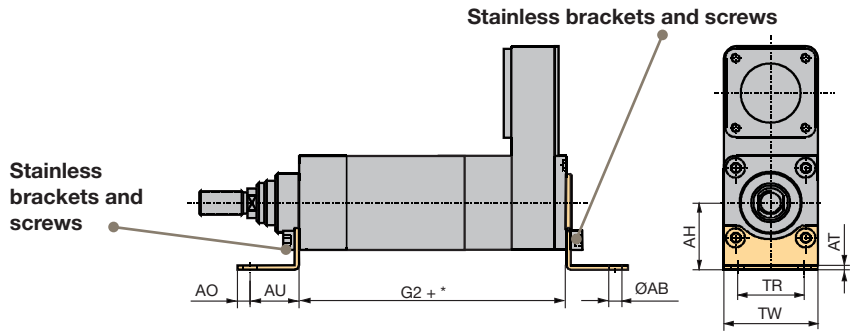

	Order no. Front & Terminal bracket	AH	AT	TR	ØAB (H14)	AO	AU	TW
		[mm]						
ETH032	0112.916	32	4	32	7	8	24	46.5
ETH050	0122.916	45	4	45	9	12	32	63.5
ETH080	0132.916	63	6	63	13.5	15	41	95

ETH100 & ETH125

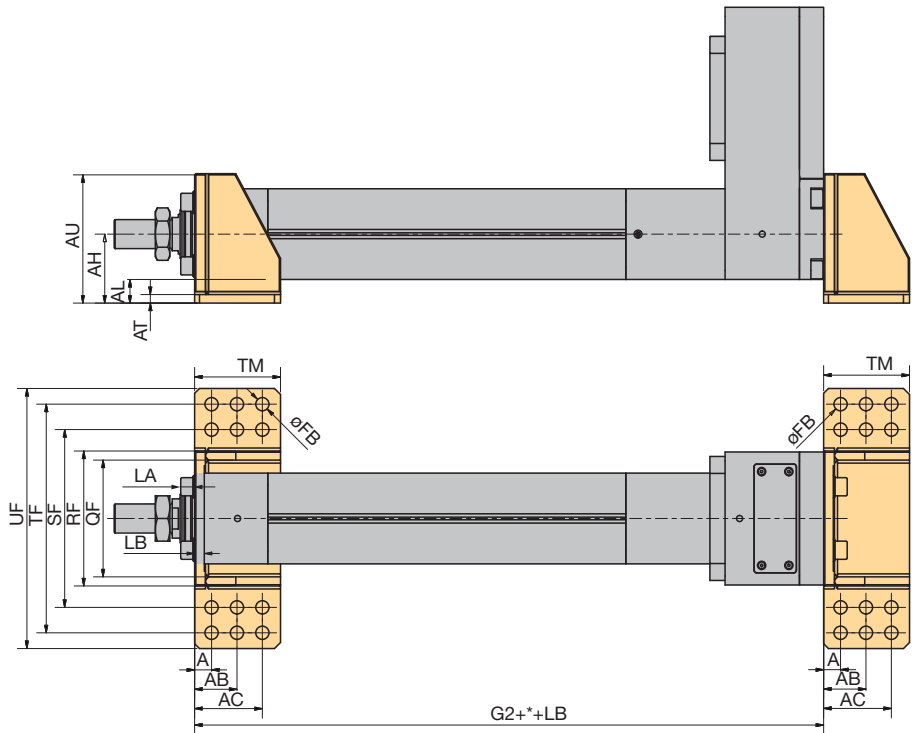
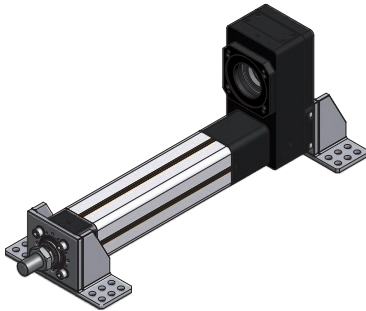

	Order no. Front & Terminal bracket	AU	AH	AL	AT	UF	TF	SF	RF	QF	LA	LB	ØFB	TM	A	AB	AC
		[mm]															
ETH100	0142.916	164	94	34	14	290	-	246	200	170	19	13	17.5	99	16.5	49.5	81.5
ETH125	0152.916	214	114	39	14	430	378	294	223	193	23	16	22	142	28	70	112

+* = Measure + Length of desired stroke ("Dimensions" see page 22).

Listed in the order code of the cylinder; the order number applies only for ordering spare parts. Spare parts delivery is including screws for cylinder mounting.

Stainless components only available for ETH032-ETH080.

* For protection classes "B" and "C", we recommend GEOMET® coated screws (thin layer corrosion protection).

Mounting Flanges



ETH032-ETH080

Mounting Flanges

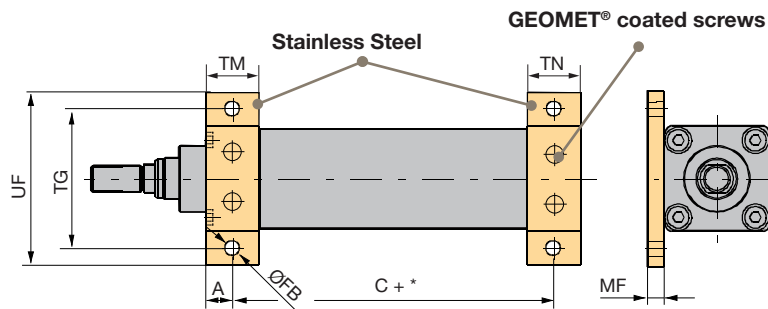

	Order no. (2 pieces)	TG	UF	ØFB	TM	MF	A	AB	TN	B	BB	BC
		[mm]										
ETH032	0112.917	62	78	6.6	25	8	12.5	-	25	-	-	-
ETH050	0122.917	84	104	9	30	10	15	-	30	-	-	-
ETH080	0132.917	120	144	13.5	40	12	20	-	40	-	-	-

ETH100 & ETH125

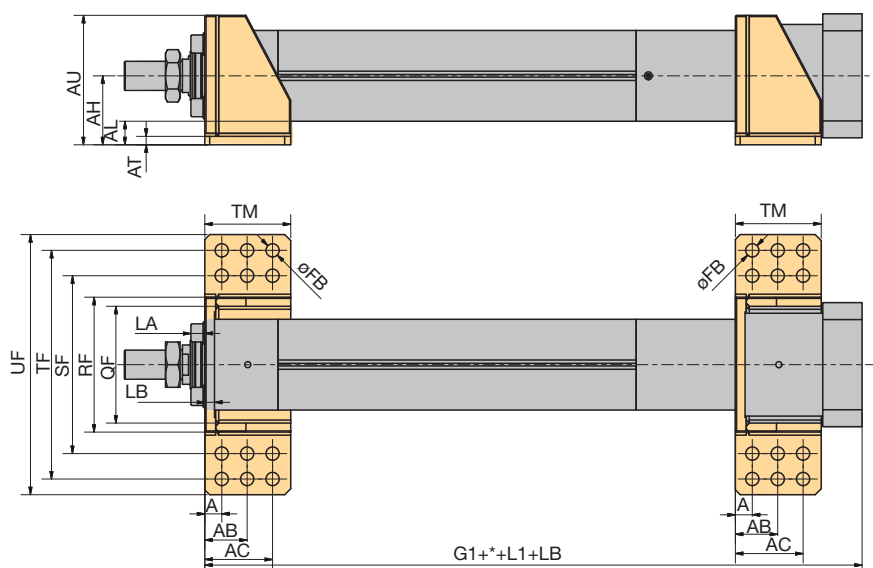
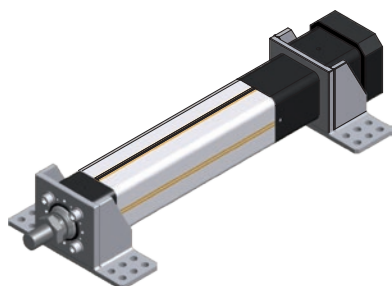

	Order no.	AU	AH	AL	AT	UF	TF	SF	RF	QF	LA	LB	ØFB	TM	A	AB	AC	
		[mm]																
ETH100	- ¹⁾	164	94	34	14	290	-	246	200	170	19	13	17.5	99	16.5	49.5	81.5	
ETH125	- ¹⁾	214	114	39	14	430	378	294	223	193	23	16	22	142	28	70	112	

+* = Measure + Length of desired stroke ("Dimensions" see page 22).

Listed in the order code of the cylinder; the order number applies only for ordering spare parts (of ETH032-ETH080 only). Spare parts delivery is including screws for cylinder mounting.

Stainless components only available for ETH032-ETH080.

¹⁾ Subsequent conversion can only be made in our factory.

* For protection classes "B" and "C", we recommend GEOMET® coated screws (thin layer corrosion protection).

Cylinder Rod Version

External thread

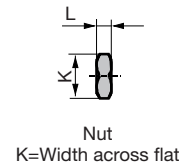
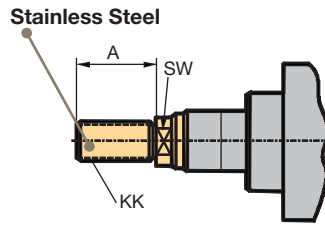
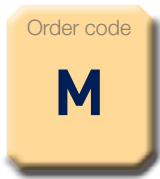

External Thread (upon delivery)				
	Weight	A	KK	SW ¹⁾
	[kg]	[mm]	[mm]	[mm]
ETH032	0.06	22	M10x1.25	10
ETH050	0.15	32	M16x1.5	17
ETH080	0.48	40	M20x1.5	22
ETH100	2.4	70	M42x2	46
ETH125	3.7	96	M48x2	55

¹⁾ SW: Width across flat (position of the flat is not fixed)

Nut				
	Weight	M	L	K ¹⁾
	[kg]	[mm]	[mm]	[mm]
ETH032	0.01	M10x1.25	5	17
ETH050	0.02	M16x1.5	8	24
ETH080	0.04	M20x1.5	10	30
ETH100	0.27	M42x2	16	65
ETH125	0.60	M48x2	24	75

¹⁾ K: Width across flat
The nut is included in the delivery.

Internal Thread

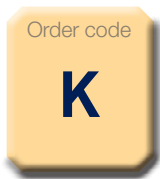
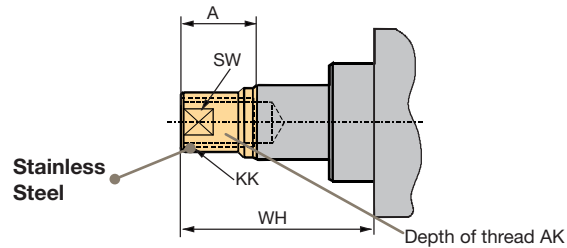

Internal Thread							
	Weight	A	KK (Option F)	KK (Option K)	AK	WH	SW ¹⁾
	[kg]	[mm]	[mm]	[mm]	[mm]	[mm]	[mm]
ETH032	0.04	14	M10x1.25		20	32	12
ETH050	0.14	24	M16x1.5		25	50	20
ETH080	0.42	29	M20x1.5		35	59	26
ETH100	2.2	60	M42x2	M45x3	50	92	60
ETH125	4.3	90	M48x2	M45x3	60	123	70

¹⁾ SW: Width across flat (position of the flat is not fixed)

Spherical Rod Eye

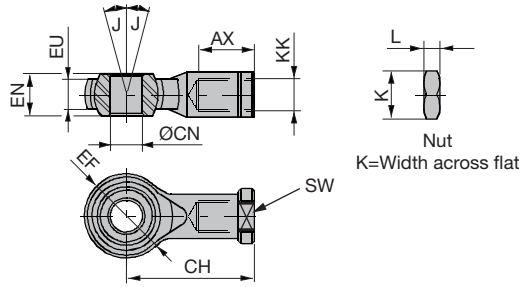

	Order no.		Weight	KK	SW ¹⁾	ØCN	EN	EU	AX	CH	ØEF	J	K	L
	Standard	Stainless												
			[kg]	[mm]	[mm]	[mm]	[mm]	[mm]	[mm]	[mm]	[mm]	[°]	[mm]	[mm]
ETH032	4078-10	P1S-4JRT	0.07	M10x1.25	17	10 H9	14	10.5	20	43	28	13	17	5
ETH050	4078-16	P1S-4MRT	0.23	M16x1.5	22	16 H9	21	15.0	28	64	42	15	24	8
ETH080	4078-20	P1S-4PRT	0.41	M20x1.5	32	20 H9	25	18.0	33	77	50	14	30	10
ETH100	0142.920-01	0142.920-02	2.8	M42x2	60	40 H7	49	7	60	142	90	16	65	15
ETH125	0152.920-01	not available	5.0	M48x2	65	50 H7	60	45	65	160	116	14	75	24

Listed in the order code of the cylinder; the order number applies only for ordering spare parts. Prerequisite is a cylinder rod with external thread.
¹⁾ SW: Width across flat (position of the flat is not fixed)

Alignment Coupler

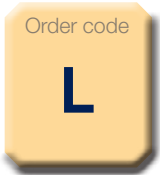

For mounting at the extremity of the cylinder rod

- Balances misalignments
- Enlarges the mounting tolerance
- Simplifies the cylinder mounting
- Increases the service life of the cylinder guidings
- Compensates the offset between components and relieves the guiding from lateral force influences
- The traction/thrust force bearing capacity remains

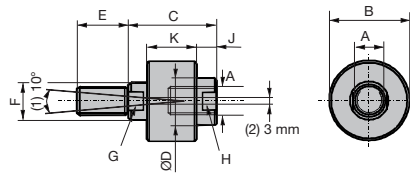

(1): Angle offset
(2): Radial offset
E: Hole dimension for depth

	Part No.	Weight	A	B	C	ØD	E	F	G	H	J	K
		[kg]	[mm]	[mm]	[mm]	[mm]	[mm]	[mm]	[mm]	[mm]	[mm]	[mm]
ETH032	LC32-1010	0.26	M10x1.25	40	51	19	19	16	13	16	13	26
ETH050	LC50-1616	0.64	M16x1.5	54	59	32	29	25	22	29	14	33
ETH080	LC80-2020	1.30	M20x1.5	54	59	32	29	25	22	29	14	33
ETH100	- ¹⁾	4.5	M39x2 ²⁾	101.6	111.1	57.2	57.2	44.5	38	49	22.2	69.9
ETH125	0152.921	9.0	M48x2	127	142.9	76.2	76.2	57.2	49.3	67	35	85.8

Listed in the order code of the cylinder; the order number applies only for ordering spare parts. Prerequisite is a cylinder rod with external thread. Only available in protection option A (IP54 with galvanized screws).

¹⁾ Subsequent conversion from rod end can only be made in our factory.

²⁾ Attention: Thread M39x2 differs from the standard (M42x2).

Outrigger Bearing - Parallel Guiding

Order code

R

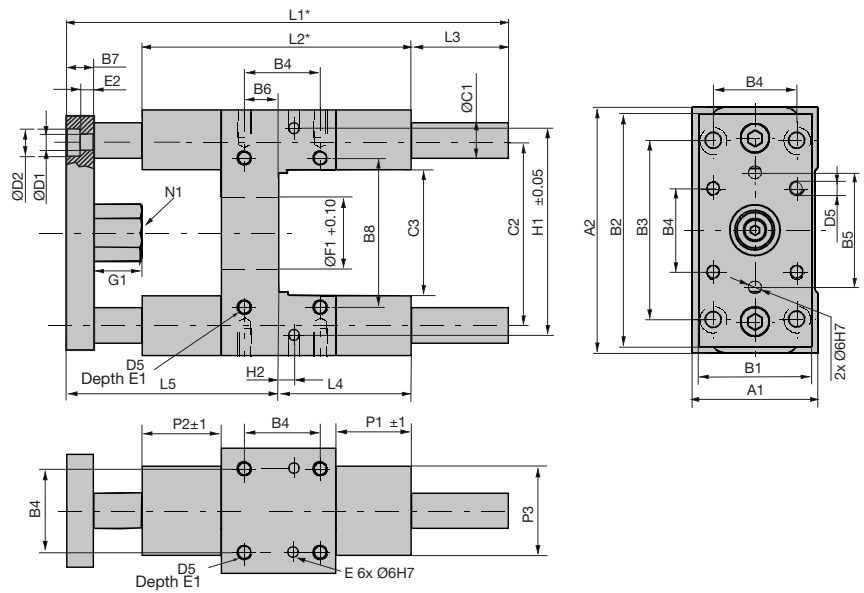
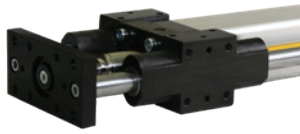

Function of outrigger bearing:

- Additional stability and precision
- Anti-rotation device for higher torques
- Absorption of lateral forces

Option R:

Outrigger bearing with ball bushings

(available only in protection class option A, "Order Code" see page 52)

- Main casting extruded aluminum
- 2 hardened steel guiding rods
- Linear ball bearings

When sizing the drive train of an ETH electro cylinder with outrigger bearing, increased friction losses must be taken into consideration

Note:

¹⁾ xxxx corresponds to the customized stroke. For information about this value please contact Parker.

²⁾ The specified axial traction force on the front flange must not be exceeded

+* = Measure + Length of desired stroke ("Dimensions" see page 22).

available for ETH032-ETH080.

For the ETH080, the standard pneumatic outrigger bearing modules cannot be used.

	Unit	ETH032	ETH050	ETH080
Part-No. - Option R ¹⁾		0112.040-xxxx	0122.040-xxxx	0132.040-xxxx
Max. permitted axial traction force ²⁾	[N]	3700	8000	9500
A1	[mm]	50	70	105
A2	[mm]	97	137	189
B1	[mm]	45	63	100
B2	[mm]	90	130	180
B3	[mm]	78	100	130
B4	[mm]	32.5	46.5	72
B5	[mm]	50	72	106
B6	[mm]	4	19	21
B7	[mm]	12	15	20
B8	[mm]	61	85	130
ØC1	[mm]	12	20	25
C2	[mm]	73.5	103.5	147
C3	[mm]	50	70	105
ØD1	[mm]	6.6	9	11
ØD2	[mm]	11	14	17
D5	[mm]	M6	M8	M10
E (Depth)	[mm]	10	10	10
E1 (Depth)	[mm]	12	16	20
E2 (Depth)	[mm]	7	9	11
ØF1	[mm]	30	40	60
G1	[mm]	17	27	32
H1	[mm]	81	119	166
H2	[mm]	11.7	4.2	15
L1+*	[mm]	150	192	247
L2	[mm]	120	150	200
L3+*	[mm]	15	24	24
L4	[mm]	71	79	113
L5	[mm]	64	89	110
N1	[mm]	17	24	30
P1	[mm]	36	42	50
P2	[mm]	31	44	52
P3	[mm]	40	50	70
Total mass with zero stroke	[kg]	0.97	2.56	6.53
Moving mass zero stroke	[kg]	0.60	1.84	4.36
Additional mass	[kg/m]	1.78	4.93	7.71

Permitted load / lifetime

Outrigger bearing with ball bushings (Option R)

ETH032

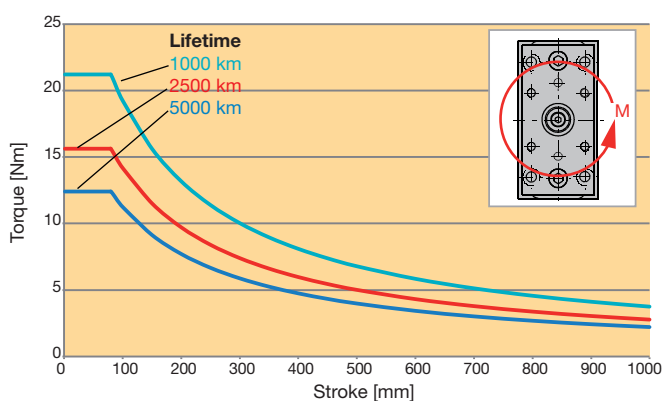
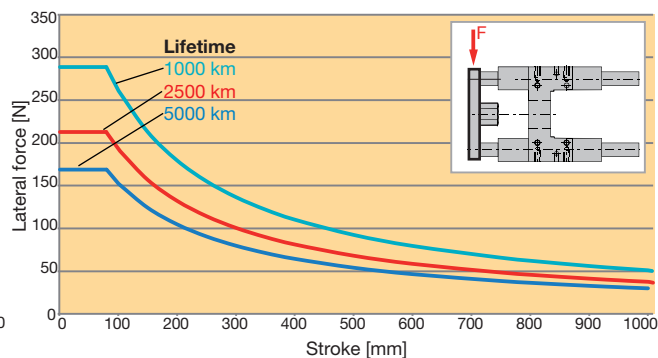
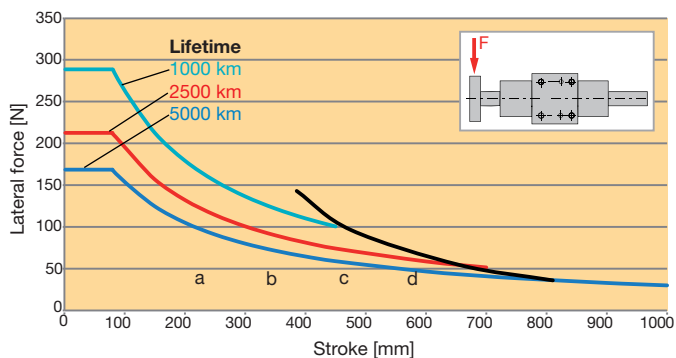

ETH050

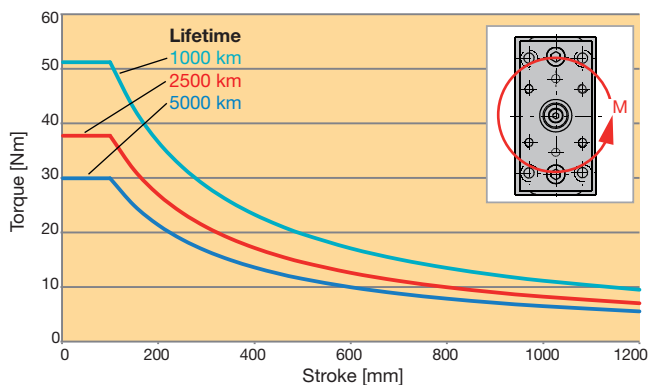
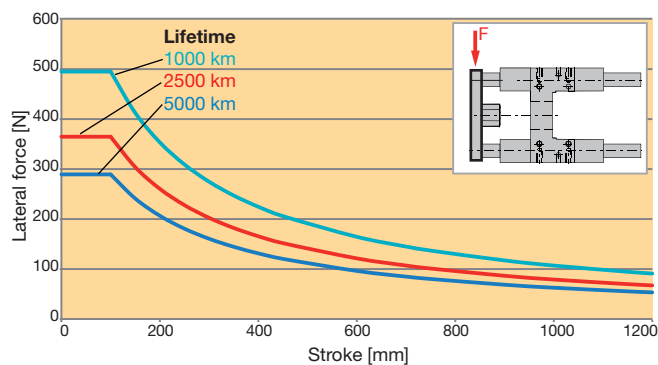
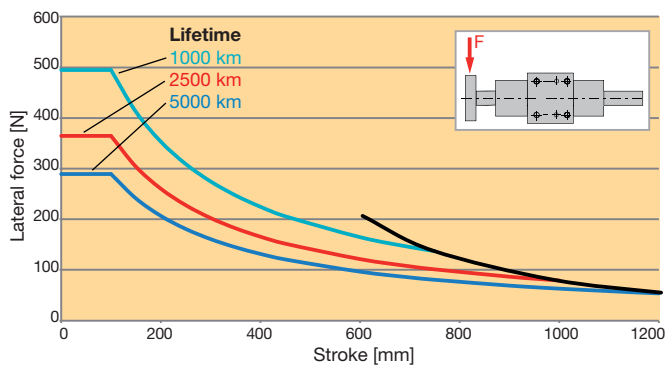

The diagrams apply for a medium travel speed of 0.5 m/s, an ambient temperature of 20 °C.

Outrigger bearing with ball bushings (Option R)

ETH080

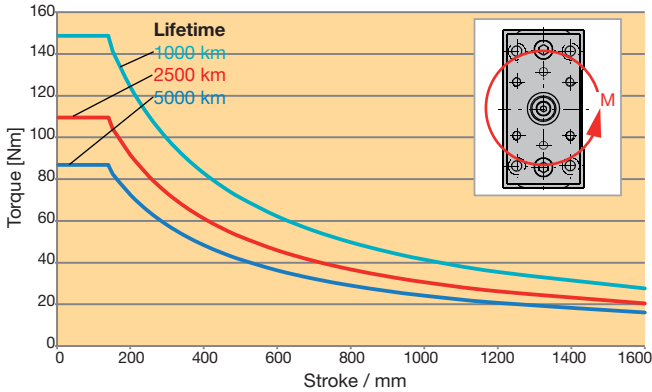
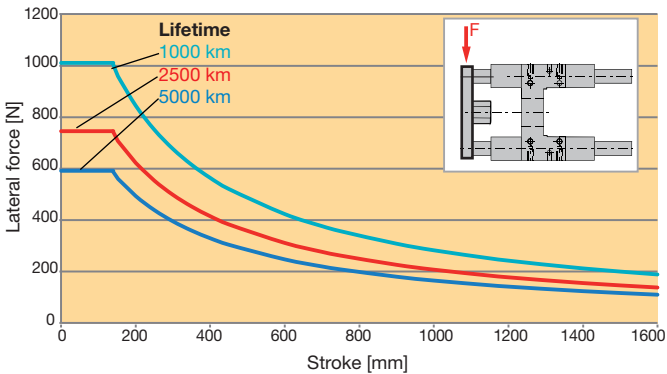
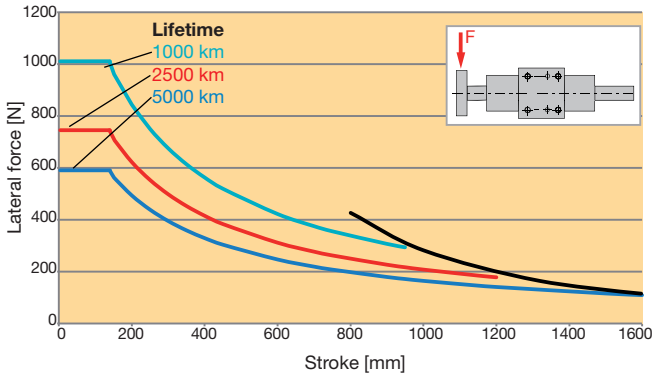

The diagrams apply for a medium travel speed of 0.5 m/s, an ambient temperature of 20 °C.

Accessories

Force sensors - Spherical rod eye with integrated force sensor

Swivel heads are important construction components with respect to rotary, pivoting and tilting movements. Force measurements are more and more frequently required in applications.

The force transducers are suitable for direct mounting on the cylinder rod. They can, for example, be used to measure contact forces or overloads. Thanks to the thin film technology, the swivel head force transducers are very robust and reliable. An integrated amplifier emits an output signal of 4...20 mA.

The sensors correspond to the EN 61326 standard for electromagnetic compatibility (EMC) and are sized to pick up traction/thrust forces.



Features

- Measuring range: Traction/thrust forces up to ±114 kN
- Thin film implants (instead of conventional bonded foil strain gauges)
- Corrosion resistant stainless steel version
- Integrated amplifier
- Small temperature drift
- Long term stability
- High shock and vibration resistance
- For dynamic or static measurements
- Good repeatability
- Simple mounting
- Also available in ATEX design ^{1) 2)}. Authorized for gas atmospheres zone 1 and zone 2.



Connection of the force sensors to Compax3 with Option M21 is possible.

Technical Features

	Unit	Spherical rod eye with integrated force sensor								With External Thread				
		ETH032			ETH050			ETH080		ETH100	ETH125			
		M05	M10	M16	M05	M10	M20	M05	M10	M10/M20	M10	M20		
Material	-	Stainless steel												
Protection class	-	IP67												
Ambient temperature	[°C]	-20 to +80												
Measuring range	[kN]	±3.7	±3.7	±2.4	±9.3	±7.0	±4.4	±17.8	±25.1	±56.0	±88.7	±114.0		
Linearity deviation of m.v.	[N]	±20			±68		±44	±90		±2000				
Part N° (standard option).	-	0111.916		0111.917	0121.916		0121.917	0121.918	0131.916		0131.917	0141.916	0141.917	0141.918
Part N° (ATEX option ¹⁾²⁾)	-	0111.946		n.a.	0121.946		0121.947	n.a.	0131.946		0131.947	n.a.	n.a.	n.a.

For ETH032-ETH080: Only possible with cylinder rod end "M" (external thread).

For ETH100, ETH125: Only possible with cylinder rod end "K".

A subsequent conversion from another rod end to M or K is generally **NOT** possible.

¹⁾ The ATEX approval of the force sensors is only met, if the sensor is operating with an ATEX authorized isolated switch amplifiers and an ATEX authorized cable.

²⁾ Please refer to the installation and operating instructions in the supplied operating manual.

Version for ETH032

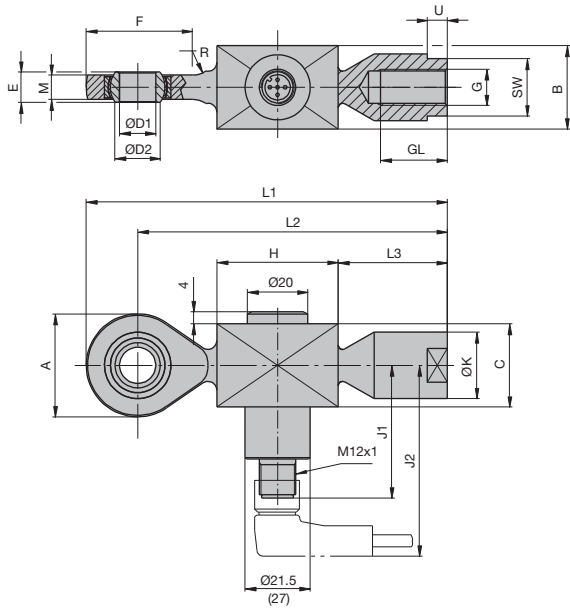

Version for ETH050 & ETH080

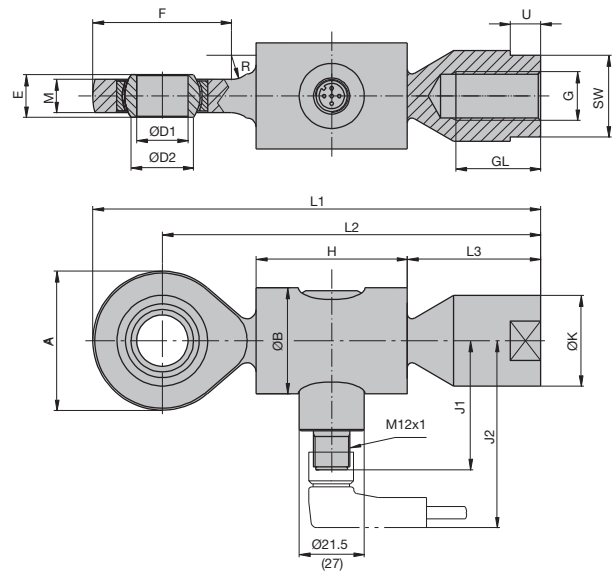

Dimensions [mm]

Dimensions - Non ATEX design (ATEX design)

	A	B	ØB	C	ØD1	ØD2 0.008	E	F	G	GL	H	J1	J2	ØK	L1	L2	L3	M	SW ¹⁾	U
for ETH032	34	27	-	27	12	15	10	35	M10x1.25	21	40	44 (70)	63 (89)	22	119	102	36	8	19	8
for ETH050	46	-	35	-	17	20.7	14	46	M16x1.5	28	50	44 (70)	63 (89)	30	148	125	44	11	27	12
for ETH080	53	-	54	-	20	24.2	16	54	M20x1.5	33	54	44 (78)	63 (97)	35	171	144.5	54	13	32	13

¹⁾ SW: Width across flat

Version for ETH100 & ETH125

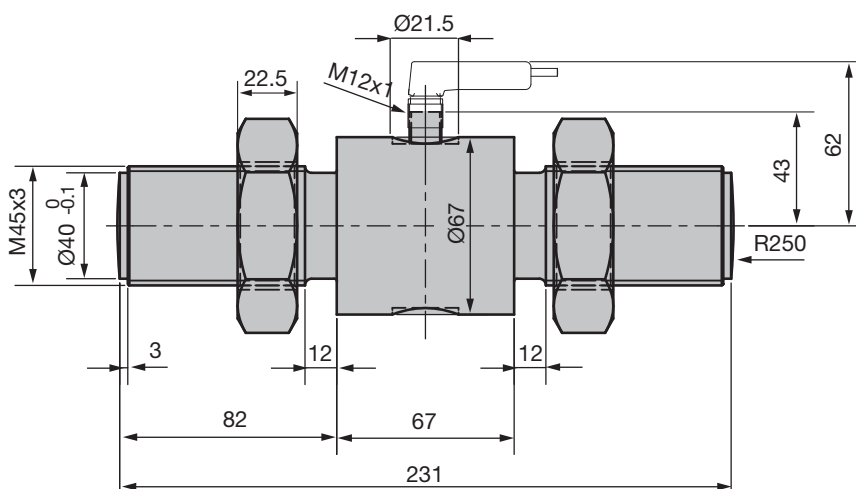

Dimensions [mm]

Electrical connection

Power supply $U_B = 10...30$ VDC
Analog output 4...20 mA (two-wire technology)

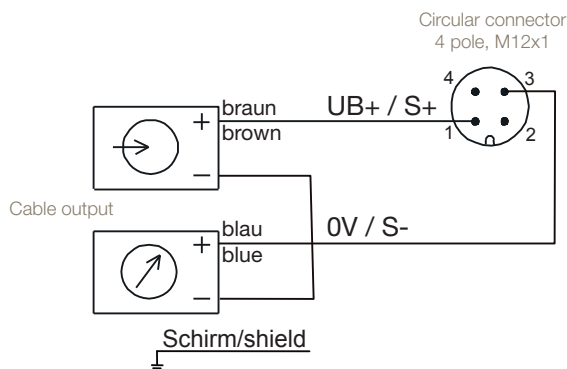
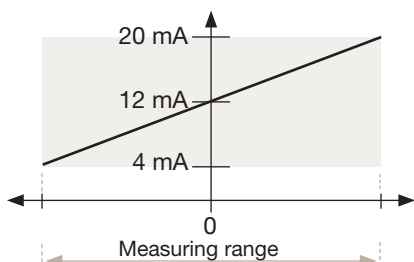

ATEX option

Technical data, isolated switch amplifiers ¹⁾²⁾

Part No.	KFD2-STC4-Ex1
Technical Characteristics	"1-channel (Operation of 1 force sensor maximum), transmits the analogue measurement sign to the Non-EX-zone"
ATEX Classification	"II (1)GD [EEx ia] IIC [electrical circuit(s) in zone 0/1/2] II 3G EEx nA II T4 [device/installation site in zone 2]"
	The device is approved for safe circuits up to Ex-zone 0 (gas). Suitable for installation in zone 2
Supply voltage	20 ... 35 V DC
Power consumption	1,9 W
Analog output	0/4 ... 20 mA
Ambient temperature	-20°C ... +60°C
Protection class	IP20

Dimensions, isolated switch amplifiers

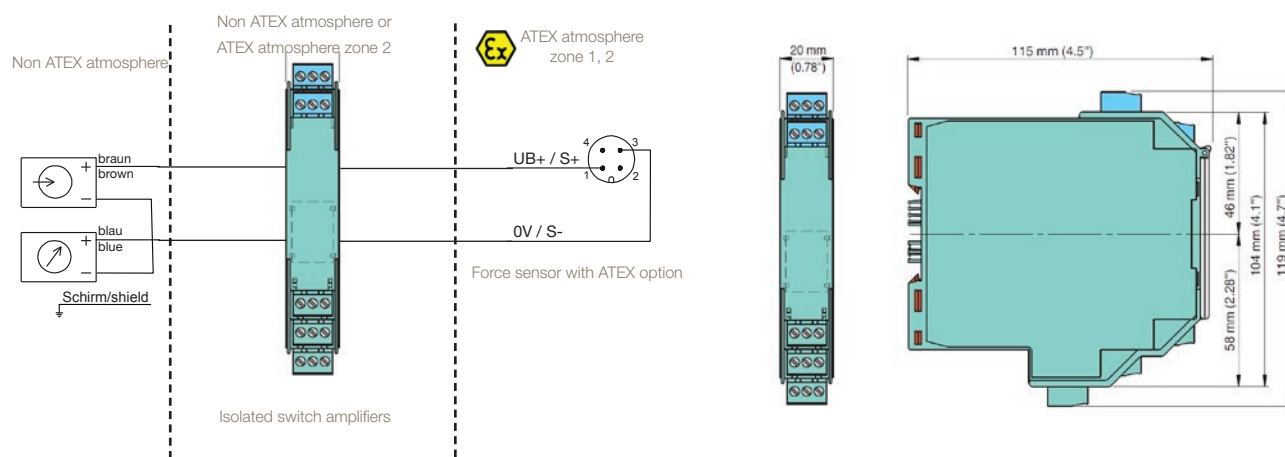

Part No.	Cable for force sensor
080-900446	Force sensor cable (PUR), straight connector, M12 with flying leads, 2 m
080-900447	Force sensor cable (PUR), straight connector, M12 with flying leads, 5 m
080-900456	Force sensor cable (PUR), angle connector, M12 with flying leads, 2 m
080-900457	Force sensor cable (PUR), angle connector, M12 with flying leads, 5 m
Part No.	Cable for force sensor with ATEX design
080-900464	Force sensor cable ATEX, straight plug, M12 flying leads, 5 m
080-900465	Force sensor cable ATEX, angle plug, M12 flying leads, 5 m

¹⁾ The ATEX approval of the force sensors is only met if the sensor is operating with an ATEX authorized isolated switch amplifiers and an ATEX authorized cable.

²⁾ Please refer to the installation and operating instructions in the supplied manual.

Initiators / Limit Switches

Sensors for non-explosive atmospheres

The position sensors can be mounted in the longitudinal grooves of the cylinder body and are flush to the body; eliminating protruding edges. The initiator cable is hidden under the yellow cover. The permanent

magnet integrated into the screw nut actuates the initiators. Fitting sensors are available as optional accessories.

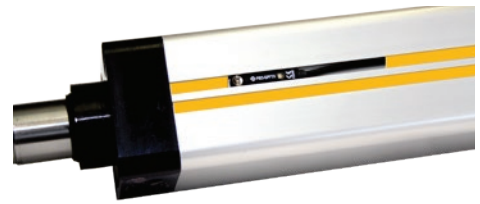

ETH032, ETH050 2 grooves each on 2 opposite sides.
ETH080, ETH100 2 grooves each on all sides.

The following initiator types are available for the ETH cylinder series:



Info: Only use PNP types for ETH with Compax3.

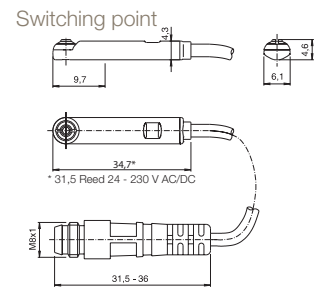

Dimensions [mm]

Magnetic cylinder sensors

Type	Function	LED	Logic	Cable	Continuous current	Current consumption	Supply voltage	Switching frequency	compatible with Compax3, SLVD-N, TPD-M
P8S-GPFLX	N.O.	yes	PNP	3 m	max. 100 mA	max. 10 mA	10-30 VDC	1 kHz	yes
P8S-GNFLX			NPN						No
P8S-GPSHX			PNP	0.3 m cable with M8 connector					yes
P8S-GNSHX			NPN						No
P8S-GQFLX	N.C.		PNP	3 m					yes
P8S-GMFAX			NPN						No
P8S-GQSHX			PNP	0.3 m cable with M8 connector					yes
P8S-GMSHX			NPN						No

Sensors for explosive atmospheres (ATEX) ¹⁾

In explosive atmospheres ATEX approved sensors must be used exclusively.
Parker magnetic cylinder sensors are rated as intrinsically safe electrical equipment. They must be used with isolated switch amplifiers with

certificates of conformity for explosive atmospheres.
These sensors are not completely flush with the profile: the initiators protrude by about 1 mm.

Technical data

Order code	MZT8-2V8-N-KWB
ATEX Classification	 "II 1G Ex ia IIC T4 II 1D Ex ia IIIC T135°C Da"
	Authorized for the operation in ATEX atmosphere Zones 0, 1 and 2.
Supply voltage	max. 20 V
Short-circuit current	max. 60 mA
Output	max. 100 mA
Effective internal inductance	max. 30 µH
Effective internal capacitance	max. 130 nF
Ambient temperature	-25°C ... +80°C
Protection class	IP67
Cable	5 m
LED	yes

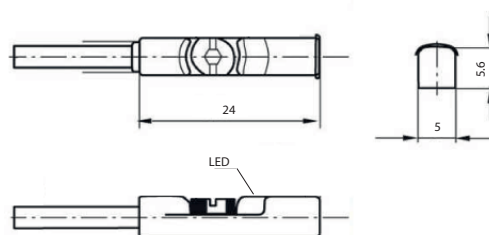

Dimensions [mm]

Technical data - Isolated switch amplifiers

Order code	EN2-2EX1
Technical Characteristics	2-channel (operating with max 2 limit switches possible), Exchange-relay (NO / NC-behavior), Line fault detection
ATEX Classification	 "II (1)G [Ex ia Ga] IIC II (1)D [Ex ia Da] IIIC II 3(1)G Ex nA nC [ia Ga] IIC t4 Gc X"
	The device is approved for intrinsically safe (Ex i) circuits up to Ex zone 0 (gas) and Ex zone 20 (dust).
Supply voltage	24 V DC ... 230 V AC/DC
Current consumption	"42 mA (24V DC), < 80 mA (230 V AC/DC)"
Max. voltage OUTPUT	9,6 V
Max. current OUTPUT	10,3 mA
Max. power OUTPUT	25 mW
Non-load voltage	8 VDC +/-10%
Switching points	"> 2,1 mA (conducting) < 1,2 mA (blocking)"
Max. switching frequency	20 Hz
Ambient temperature	-20°C ... +60°C
Protection class	IP20

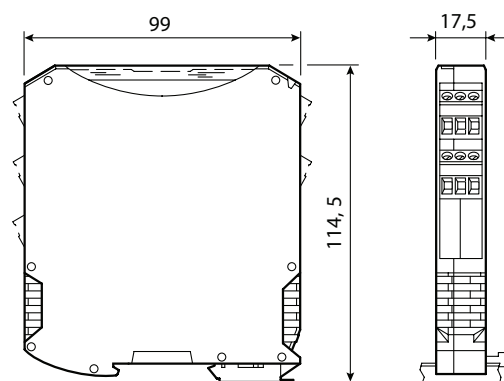

Dimensions [mm]

¹⁾ Please refer to the installation and operating instructions in the supplied manual.

Drive Train Selection ¹⁾

Example for Sizing with Predefined Drive Trains

In order to simplify the dimensioning process for a complete drive train, We have prepared an overview of predefined electro cylinders, gearboxes, motors and servo drives, which can be found on the following pages.

With a few parameters, you can directly find the order code for the required components.

Note the boundary conditions!

The following application parameters are required:

- The equivalent axial force.
(Calculation page 13 formula 3 with the forces determined as described on page 11).
- The maximum speed.



Working with the drive train table

- Select the drive trains providing the required axial force (e.g. by drawing a vertical line).
- Then select from this choice the drive trains, that are able to travel at the required speed (e.g. by drawing a second vertical line).
- The suitable drive train can then be selected from the remaining choice, if necessary by comparing additional characteristics.

Please check if all given characteristics (such as max. acceleration, supply voltage etc.) are suitable for your application.

Example:

Required data

Equivalent axial force: 5000 N
Speed: 300 mm/s

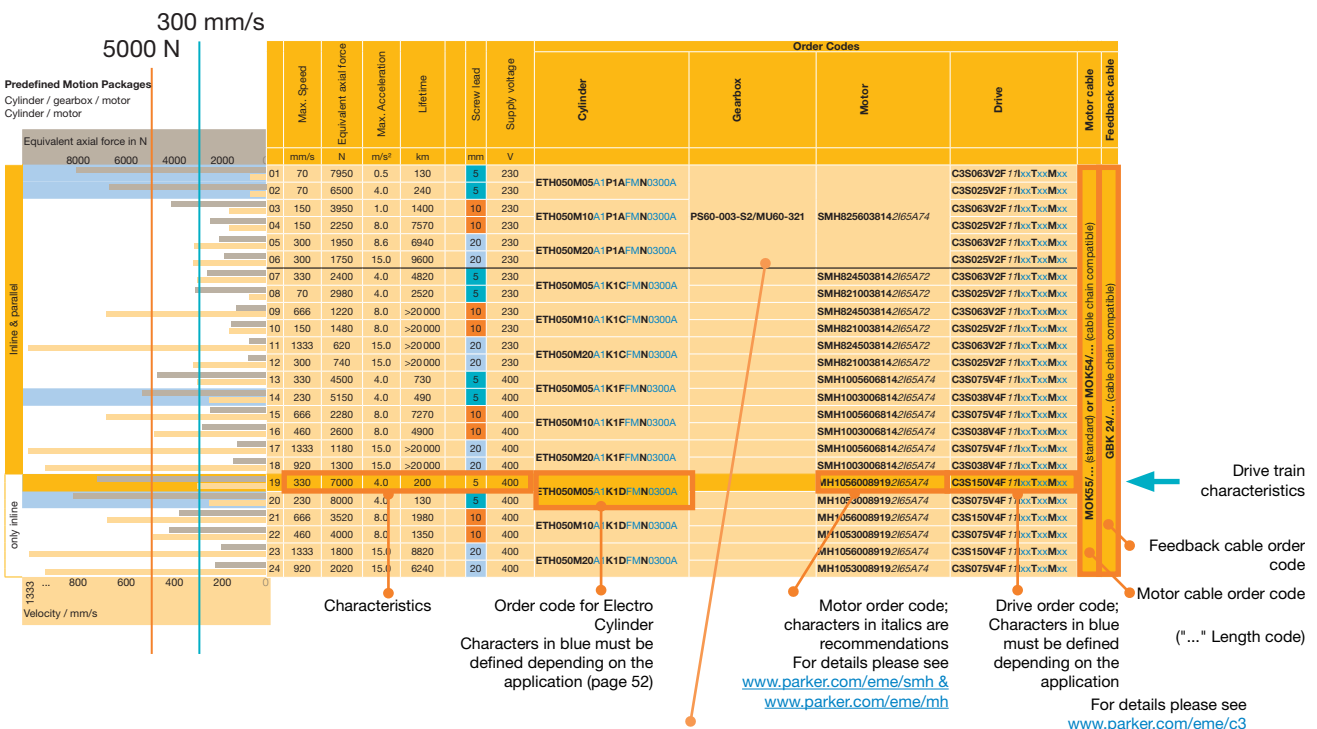

¹⁾ does not apply for ATEX Cylinder

Order code for gearbox
For details please see
www.parker.com/eme/gear

Motor order code;
characters in italics are
recommendations
For details please see
www.parker.com/eme/smh &
www.parker.com/eme/mh

Drive order code;
Characters in blue
must be defined
depending on the
application
For details please see
www.parker.com/eme/c3

Predefined Motion Packages ETH032 ¹⁾

with Compax3, PSD1

In order to simplify the representation, we assumed boundary conditions which must be adhered to without exception in your application, otherwise the product combinations suggested here might not work. In this case, the application must be dimensioned conventionally.

¹⁾ does not apply for ATEX Cylinder

Predefined Motion Packages

Cylinder / gearbox / motor / drive controller / cable

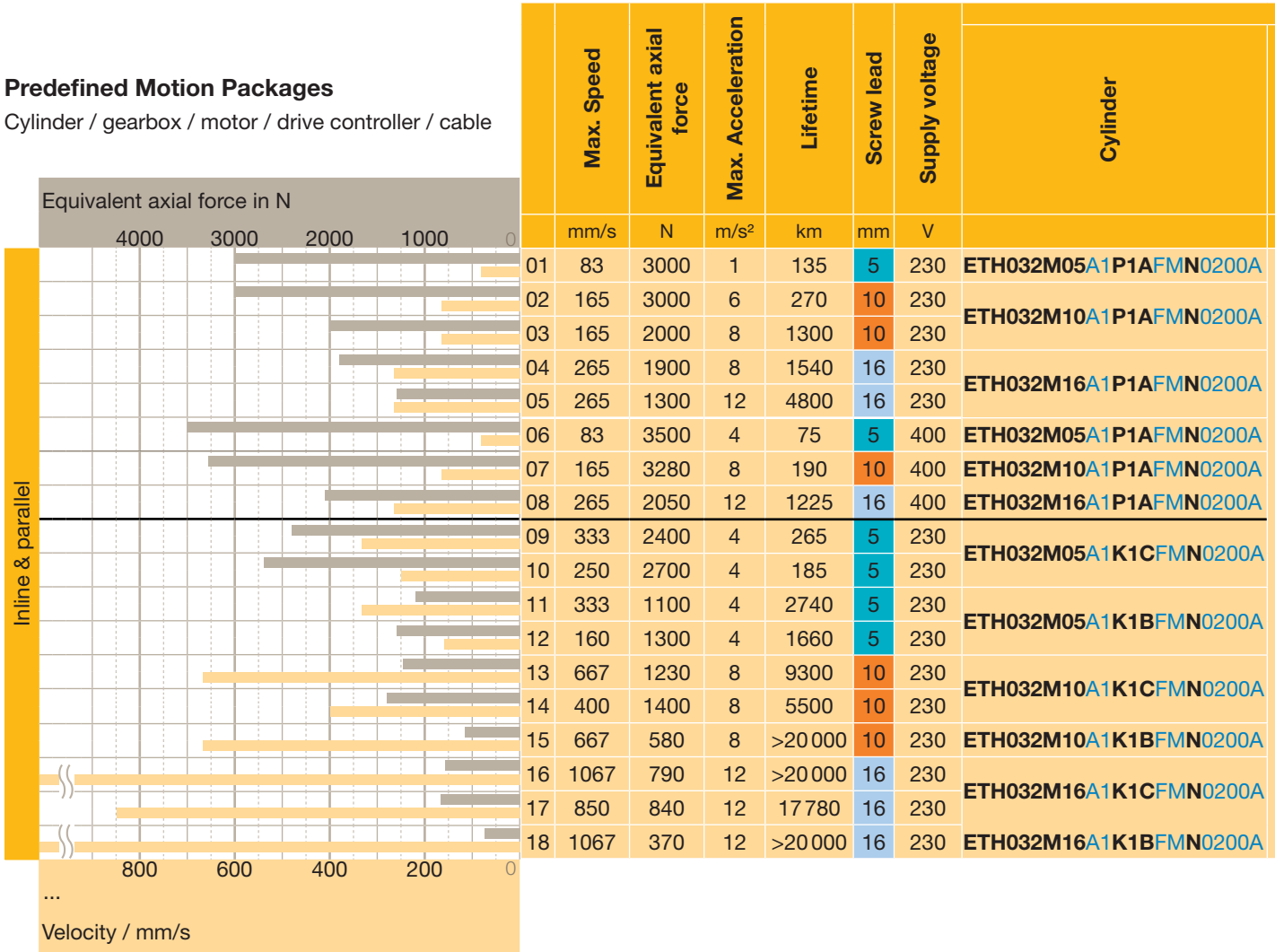

Basic Application Assumptions:

- Stroke from 50 to 400 mm
- Horizontal movement
- The characteristics of the individual components are not to be exceeded
 - with parallel motor: respect transmissible torque depending on the motor speed n
 - permissible axial thrust forces must be respected
- Ambient conditions
- ...
- Linear acceleration
- Maximum acceleration given = deceleration times
- Application factor = 1.0
- The calculation is based on the assumption: without standstill time (i.e. if there are standstill times in the application, only the power reserve is increased)
- 40 °C ambient temperature, with gearbox 20 °C ambient temperature
- up to 1000 m above sea level

Order Codes						
Gearbox	Motor	Drive Compax3	Motor Cable	Feedback cable	Drive PSD1	Cable
	<i>xx</i> : choose the right feedback depending of the application and drive used					
PE3-003-10M060/075/11/23	SMH60601,4511 <i>2l65xx4</i>	C3S025V2F 11 <i>lxxTxxMxx</i>	MOK55/... (standard) or MOK54/... (cable chain compatible)	GBK 24/... (cable chain compatible)	PSD1SW1200...	CBM....
PE3-003-10M080/100/14/30	SMH826003814 <i>2l65xx4</i>	C3S025V2F 11 <i>lxxTxxMxx</i>			PSD1SW1200...	
PE3-003-10M060/075/11/23	SMH60601,4511 <i>2l65xx4</i>	C3S015V4F 11 <i>lxxTxxMxx</i>			PSD1MW1200....	
PE3-003-10M080/100/14/30	SMH826003814 <i>2l65xx4</i>	C3S038V4F 11 <i>lxxTxxMxx</i>			PSD1MW1300...	
without gearbox	SMH824503814 <i>2l65xx2</i>	C3S063V2F 11 <i>lxxTxxMxx</i>	PSD1SW1300...			
	SMH826003814 <i>2l65xx4</i>					
	SMH60451,4511 <i>2l65xx2</i>	C3S025V2F 11 <i>lxxTxxMxx</i>	PSD1SW1200...			
	SMH60601,4511 <i>2l65xx4</i>					
	SMH824503814 <i>2l65xx2</i>	C3S063V2F 11 <i>lxxTxxMxx</i>	PSD1SW1300...			
	SMH826003814 <i>2l65xx4</i>					
	SMH60451,4511 <i>2l65xx2</i>	C3S025V2F 11 <i>lxxTxxMxx</i>	PSD1SW1200...			
	SMH824503814 <i>2l65xx2</i>		C3S063V2F 11 <i>lxxTxxMxx</i>	PSD1SW1300...		
SMH826003814 <i>2l65xx4</i>	C3S025V2F 11 <i>lxxTxxMxx</i>	PSD1SW1200...				
SMH60451,4511 <i>2l65xx2</i>						

Order codes:

bold: mandatory so that the package is combinable

italics: recommended/standard

blue: must be selected depending on the application

Hint: The examples shown here are meant to help with the dimensioning process. As many parameters interact in this kind of drive package, the examples make no claim to be complete.

Predefined Motion Packages ETH050 ¹⁾

with Compax3, PSD1

In order to simplify the representation, we assumed boundary conditions which must be adhered to without exception in your application, otherwise the product combinations suggested here might not work. In this case, the application must be dimensioned conventionally.

¹⁾ does not apply for ATEX Cylinder

Predefined Motion Packages

Cylinder / gearbox / motor / drive controller / cable

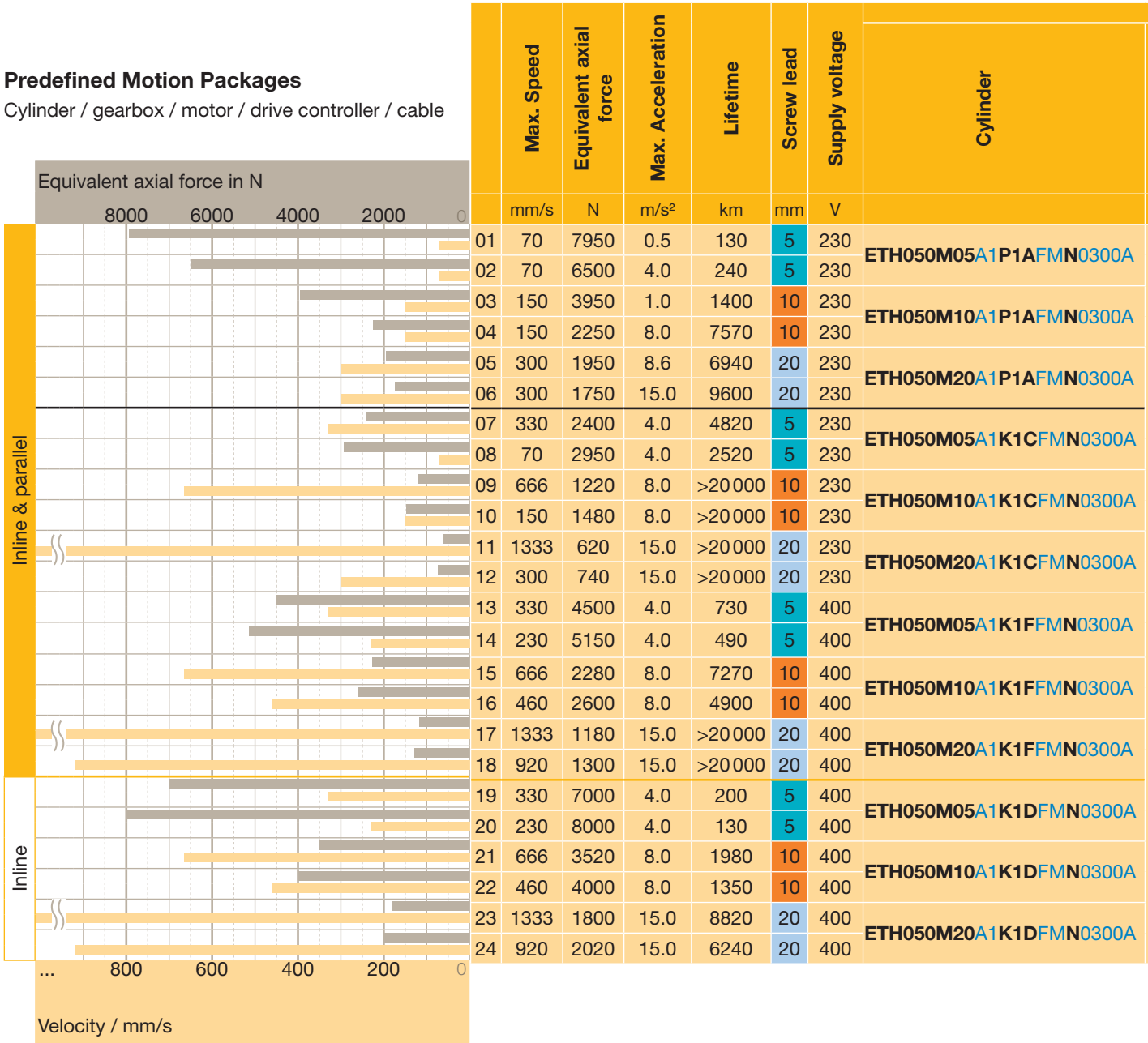

Basic Application Assumptions:

- Stroke from 50 to 600 mm
- Horizontal movement
- The characteristics of the individual components are not to be exceeded
 - with parallel motor: respect transmissible torque depending on the motor speed n
 - permissible axial thrust forces must be respected
- Ambient conditions
- ...
- Linear acceleration
- Maximum acceleration given = deceleration times
- Application factor = 1.0
- The calculation is based on the assumption: without standstill time (i.e. if there are standstill times in the application, only the power reserve is increased)
- 40 °C ambient temperature, with gearbox 20 °C ambient temperature
- up to 1000 m above sea level

Order Codes									
Gearbox	Motor	Drive Compax3	Motor Cable	Feedback cable	Drive PSD1M	Cable			
PE3-003-10M080/100/14/30	SMH8256038142165xx4	C3S063V2F 11lxxTxxMxx	MOK55/... (standard) or MOK54/... (cable chain compatible)	GBK 24/... (cable chain compatible)	PSD1SW1300...	CBM...			
		C3S025V2F 11lxxTxxMxx			PSD1SW1200...				
		C3S063V2F 11lxxTxxMxx			PSD1SW1300...				
		C3S025V2F 11lxxTxxMxx			PSD1SW1200...				
		C3S063V2F 11lxxTxxMxx			PSD1SW1300...				
		C3S025V2F 11lxxTxxMxx			PSD1SW1200...				
without gearbox	SMH8245038142165xx2	C3S063V2F 11lxxTxxMxx			MOK55/... (standard) or MOK54/... (cable chain compatible)		GBK 24/... (cable chain compatible)	PSD1SW1300...	CBM...
	SMH8210038142165xx2	C3S025V2F 11lxxTxxMxx						PSD1SW1200...	
	SMH8245038142165xx2	C3S063V2F 11lxxTxxMxx						PSD1SW1300...	
	SMH8210038142165xx2	C3S025V2F 11lxxTxxMxx						PSD1SW1200...	
	SMH8245038142165xx2	C3S063V2F 11lxxTxxMxx						PSD1SW1300...	
	SMH8210038142165xx2	C3S025V2F 11lxxTxxMxx						PSD1SW1200...	
	SMH10056065ET 2165xx4	C3S075V4F 11lxxTxxMxx	PSD1MW1300...						
	SMH10030065ET 2165xx4	C3S038V4F 11lxxTxxMxx	PSD1MW1300...						
	SMH10056065ET 2165xx4	C3S075V4F 11lxxTxxMxx	PSD1MW1300...						
	SMH10030065ET 2165xx4	C3S038V4F 11lxxTxxMxx	PSD1MW1300...						
	SMH10056065ET 2165xx4	C3S075V4F 11lxxTxxMxx	PSD1MW1300...						
without gearbox	MH10560089192165xx4	C3S150V4F 11lxxTxxMxx	MOK55/... (standard) or MOK54/... (cable chain compatible)	GBK 24/... (cable chain compatible)	PSD1MW1600...	CBM...			
	MH10530089192165xx4	C3S075V4F 11lxxTxxMxx			PSD1MW1300...				
	MH10560089192165xx4	C3S150V4F 11lxxTxxMxx			PSD1MW1600...				
	MH10530089192165xx4	C3S075V4F 11lxxTxxMxx			PSD1MW1300...				
	MH10560089192165xx4	C3S150V4F 11lxxTxxMxx			PSD1MW1600...				
	MH10530089192165xx4	C3S075V4F 11lxxTxxMxx			PSD1MW1300...				

Order codes:

bold: mandatory so that the package is combinable

italics: recommended/standard

blue: must be selected depending on the application

Hint: The examples shown here are meant to help with the dimensioning process. As many parameters interact in this kind of drive package, the examples make no claim to be complete.

Predefined Motion Packages ETH080 ¹⁾

with Compax3, PSD1

In order to simplify the representation, we assumed boundary conditions which must be adhered to without exception in your application, otherwise the product combinations suggested here might not work. In this case, the application must be dimensioned conventionally.

¹⁾ does not apply for ATEX Cylinder

Predefined Motion Packages

Cylinder / gearbox / motor / drive controller / cable

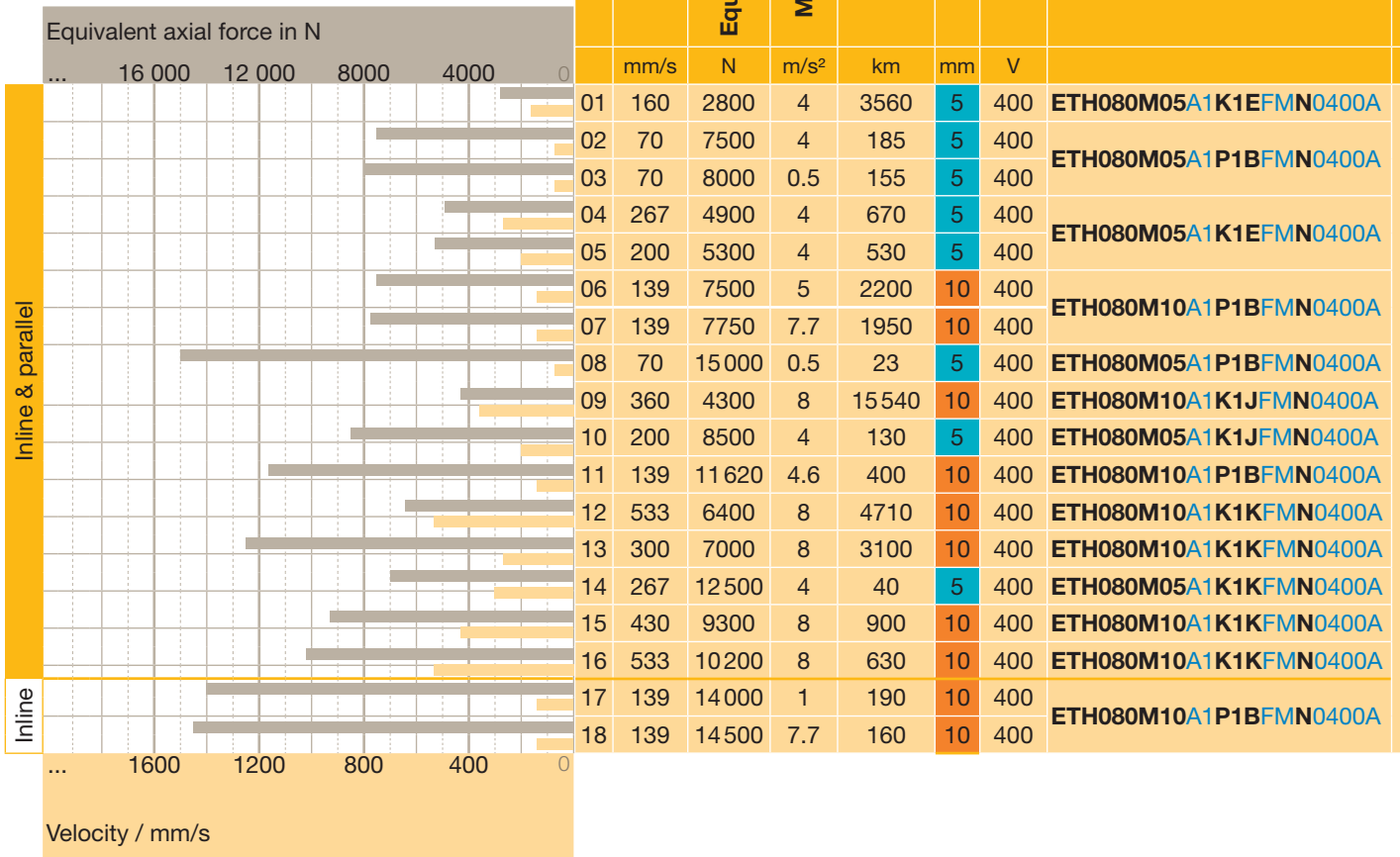

Basic Application Assumptions:

- Stroke from 50 to 800 mm
- Horizontal movement
- The characteristics of the individual components are not to be exceeded
 - with parallel motor: respect transmissible torque depending on the motor speed n
 - permissible axial thrust forces must be respected
- Ambient conditions
- ...
- Linear acceleration
- Maximum acceleration given = deceleration times
- Application factor = 1.0
- The calculation is based on the assumption: without standstill time (i.e. if there are standstill times in the application, only the power reserve is increased)
- 40 °C ambient temperature, with gearbox
20 °C ambient temperature
- up to 1000 m above sea level

Order Codes						
Gearbox	Motor	Drive Compax3	Motor Cable	Feedback cable	Drive PSD1M	Cable
without gearbox	SMH823003519 <i>2165xx4</i>	C3S038V4F <i>11lxxTxxMxx</i>			PSD1MW1300...	CBM...
PE4-003-10M080/100/19/40	SMH825603819 <i>2165xx4</i>	C3S038V4F <i>11lxxTxxMxx</i>			PSD1MW1300...	
	SMH823003819 <i>2165xx4</i>	C3S038V4F <i>11lxxTxxMxx</i>			PSD1MW1200...	
	without gearbox	SMH1005606519 <i>2165xx4</i>	C3S075V4F <i>11lxxTxxMxx</i>			
PE4-003-10M095/115/19/40	SMH1003006519 <i>2165xx4</i>	C3S038V4F <i>11lxxTxxMxx</i>	①	GBK 24/... (cable chain compatible)	PSD1MW1300...	
	SMH1005606519 <i>2165xx4</i>	C3S075V4F <i>11lxxTxxMxx</i>			PSD1MW1400...	
	SMH1003006519 <i>2165xx4</i>	C3S038V4F <i>11lxxTxxMxx</i>			PSD1MW1300...	
	without gearbox	SMH1153010724 <i>2165xx4</i>			C3S075V4F <i>11lxxTxxMxx</i>	
PE4-003-10M095/130/19/40	SMH1153010819 <i>2165xx4</i>	C3S075V4F <i>11lxxTxxMxx</i>			PSD1MW1400...	
	SMH1425615524 <i>2165xx4</i>	C3S150V4F <i>11lxxTxxMxx</i>			PSD1MW1600...	
	SMH1423015524 <i>2165xx4</i>	C3S150V4F <i>11lxxTxxMxx</i>			PSD1MW1600...	
without gearbox	SMH1425615524 <i>2165xx4</i>	C3S150V4F <i>11lxxTxxMxx</i>			PSD1MW1600...	
	MH1453022524 <i>2165xx4</i>	C3S150V4F <i>11lxxTxxMxx</i>			PSD1MW1600...	
	MH1454528524 <i>3165xx4</i>	C3S300V4F <i>11lxxTxxMxx</i>			PSD1MW1800...	
	PE4-003-10M095/130/19/40	SMH1153010819 <i>2165xx4</i>	C3S075V4F <i>11lxxTxxMxx</i>	①		
SMH1155610819 <i>2165xx4</i>		C3S150V4F <i>11lxxTxxMxx</i>			PSD1MW1600...	

- ① **MOK55/...** (standard) or **MOK54/...** (cable chain compatible)
- ② **MOK56/...** (standard) or **MOK57/...** (cable chain compatible)
- ③ **MOK59/...** (standard) or **MOK64/...** (cable chain compatible)

Order codes:

bold: mandatory so that the package is combinable

italics: recommended/standard

blue: must be selected depending on the application

Hint: The examples shown here are meant to help with the dimensioning process. As many parameters interact in this kind of drive package, the examples make no claim to be complete.

Predefined Motion Packages ETH100, ETH125 ¹⁾

with Compax3, PSD1

In order to simplify the representation, we assumed boundary conditions which must be adhered to without exception in your application, otherwise the product combinations suggested here might not work. In this case, the application must be dimensioned conventionally.

¹⁾ does not apply for ATEX Cylinder

Predefined Motion Packages

Cylinder / gearbox / motor / drive controller / cable

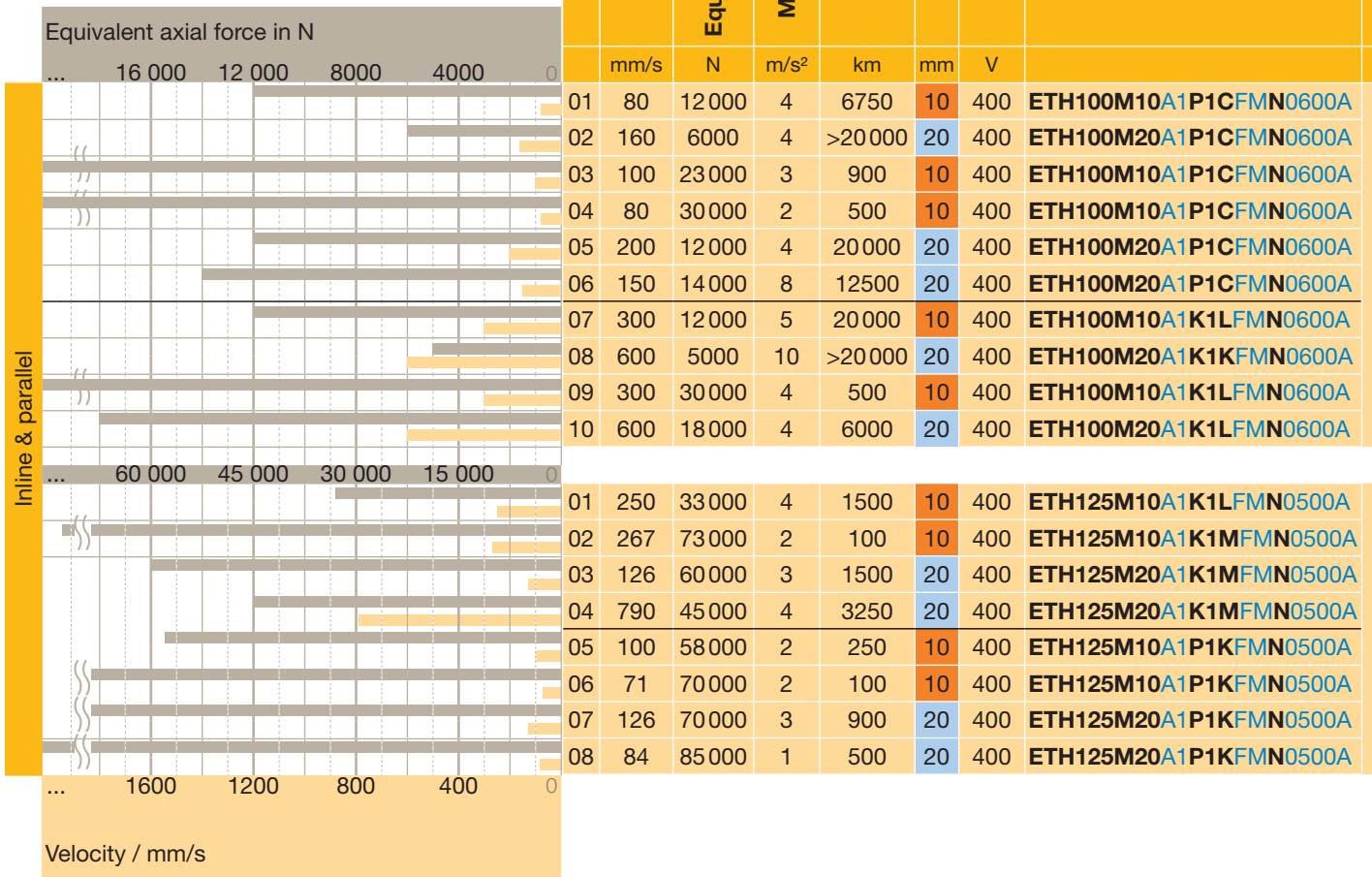

Basic Application Assumptions:

- Stroke from 100 to 600 mm
- Horizontal movement
- The characteristics of the individual components are not to be exceeded
 - with parallel motor: respect transmissible torque depending on the motor speed n
 - permissible axial thrust forces must be respected
 - Ambient conditions
 - ...
- Linear acceleration
- Maximum acceleration given = deceleration times
- Application factor = 1.0
- The calculation is based on the assumption: without standstill time (i.e. if there are standstill times in the application, only the power reserve is increased)
- 40 °C ambient temperature, with gearbox
20 °C ambient temperature
- up to 1000 m above sea level

Order Codes						
Gearbox	Motor	Drive Compax3	Motor Cable	Feedback cable	Drive PSD1M	Cable
PE5-005-10M095/115/24/50	SMH10056065242I65xx4	C3S075V4F11IxxTxxMxx	①	⑥	PSD1MW1400...	CBM
PE5-005-10M095/115/24/50	SMH10030065242I65xx4	C3S038V4F11IxxTxxMxx	①		PSD1MW1300...	
PE5-004-10M130/185/24/50	SMH14230155242I65xx4	C3S150V4F11IxxTxxMxx	②		PSD1MW1600...	
PE5-005-10M130/185/24/50	SMH14230155242I65xx4	C3S150V4F11IxxTxxMxx	②		PSD1MW1600...	
PE5-004-10M130/185/24/50	SMH14230155242I65xx4	C3S150V4F11IxxTxxMxx	②		PSD1MW1600...	
PE5-005-10M130/185/24/50	SMH14230155242I65xx4	C3S150V4F11IxxTxxMxx	②		PSD1MW1600...	
without gearbox	SMH17030355382I65xx4	C3S150V4F11IxxTxxMxx	②		PSD1MW1600...	
	MH14545285242I65xx4	C3S300V4F11IxxTxxMxx	③		PSD1MW1800...	
	MH20530905382I65xx4	C3H050V4F11IxxTxxMxx	④		--	
	MH20530905382I65xx4	C3H050V4F11IxxTxxMxx	④		--	
without gearbox	MH20530705383I65xx4	C3H090V4F11IxxTxxMxx	⑤	⑥	--	
	MH265301505483M65xx4	C3H090V4F10IxxTxxMxx	⑤	⑦	--	
	MH265302205483M65xx4	C3H125V4F10IxxTxxMxx	⑤	⑦	--	
	MH265302205483M65xx4	C3H125V4F10IxxTxxMxx	⑤	⑦	--	
PE7-004-10M180/215/38/80	MH20530285383I65xx4	C3S300V4F11IxxTxxMxx	④	⑥	--	
PE7-005-10M180/215/38/80	MH20530285383I65xx4	C3S300V4F11IxxTxxMxx	④	⑥	--	
PE7-004-10M180/215/38/80	MH20530705383I65xx4	C3H050V4F11IxxTxxMxx	⑤	⑥	--	
PE7-005-10M180/215/38/80	MH20530705383I65xx4	C3H050V4F11IxxTxxMxx	⑤	⑥	--	

- ① MOK55/... (standard) or MOK54/... (cable chain compatible)
- ② MOK56/... (standard) or MOK57/... (cable chain compatible)
- ③ MOK59/... (standard) or MOK64/... (cable chain compatible)
- ④ MOK61/...,
- ⑤ MOK62/...
- ⑥ GBK24/... (cable chain compatible)
- ⑦ REK42/... (standard) or REK41/... (cable chain compatible)

Order codes:

bold: mandatory so that the package is combinable

























italics: recommended/standard

blue: must be selected depending on the application

Hint: The examples shown here are meant to help with the dimensioning process. As many parameters interact in this kind of drive package, the examples make no claim to be complete.

Order Code

	1	2	3	4	5	6	7	8	9	10	11	12
Example	ETH	050	M05	A	1	K1B	F	M	N	0200	A	Uxx

1 Series	ETH Electro Cylinder																								
2 Frame size	<table border="1"> <tr><td>032</td><td>ISO 32</td></tr> <tr><td>050</td><td>ISO 50</td></tr> <tr><td>080</td><td>ISO 80</td></tr> <tr><td>100</td><td>ISO 100</td></tr> <tr><td>125</td><td>ISO 125</td></tr> </table>	032	ISO 32	050	ISO 50	080	ISO 80	100	ISO 100	125	ISO 125														
032	ISO 32																								
050	ISO 50																								
080	ISO 80																								
100	ISO 100																								
125	ISO 125																								
3 Screw lead Mxx in mm	<table border="1"> <tr><td>M05</td><td>for ETH032, ETH050, ETH080</td></tr> <tr><td>M10</td><td>for ETH032, ETH050, ETH080, ETH100, ETH125</td></tr> <tr><td>M16</td><td>for ETH032</td></tr> <tr><td>M20</td><td>for ETH050, ETH100, ETH125</td></tr> </table>	M05	for ETH032, ETH050, ETH080	M10	for ETH032, ETH050, ETH080, ETH100, ETH125	M16	for ETH032	M20	for ETH050, ETH100, ETH125																
M05	for ETH032, ETH050, ETH080																								
M10	for ETH032, ETH050, ETH080, ETH100, ETH125																								
M16	for ETH032																								
M20	for ETH050, ETH100, ETH125																								
4 Motor mounting position, housing orientation, groove orientation ¹⁾	<table border="1"> <tr> <td>A</td> <td></td> <td>In-line + groove for initiator 3 & 9 o'clock (standard)</td> </tr> <tr> <td>B</td> <td></td> <td>In-line + groove for initiator 6 & 12 o'clock</td> </tr> <tr> <td>C</td> <td></td> <td>Parallel 12 o'clock / groove for initiator 3 & 9 o'clock</td> </tr> <tr> <td>D</td> <td></td> <td>Parallel 12 o'clock / groove for initiator 6 & 12 o'clock</td> </tr> <tr> <td>E</td> <td></td> <td>Parallel 3 o'clock / groove for initiator 3 & 9 o'clock</td> </tr> <tr> <td>G</td> <td></td> <td>Parallel 6 o'clock / groove for initiator 3 & 9 o'clock</td> </tr> <tr> <td>J</td> <td></td> <td>Parallel 9 o'clock / groove for initiator 3 & 9 o'clock</td> </tr> <tr> <td>K</td> <td></td> <td>Parallel 9 o'clock / groove for initiator 6 & 12 o'clock</td> </tr> </table>	A		In-line + groove for initiator 3 & 9 o'clock (standard)	B		In-line + groove for initiator 6 & 12 o'clock	C		Parallel 12 o'clock / groove for initiator 3 & 9 o'clock	D		Parallel 12 o'clock / groove for initiator 6 & 12 o'clock	E		Parallel 3 o'clock / groove for initiator 3 & 9 o'clock	G		Parallel 6 o'clock / groove for initiator 3 & 9 o'clock	J		Parallel 9 o'clock / groove for initiator 3 & 9 o'clock	K		Parallel 9 o'clock / groove for initiator 6 & 12 o'clock
A		In-line + groove for initiator 3 & 9 o'clock (standard)																							
B		In-line + groove for initiator 6 & 12 o'clock																							
C		Parallel 12 o'clock / groove for initiator 3 & 9 o'clock																							
D		Parallel 12 o'clock / groove for initiator 6 & 12 o'clock																							
E		Parallel 3 o'clock / groove for initiator 3 & 9 o'clock																							
G		Parallel 6 o'clock / groove for initiator 3 & 9 o'clock																							
J		Parallel 9 o'clock / groove for initiator 3 & 9 o'clock																							
K		Parallel 9 o'clock / groove for initiator 6 & 12 o'clock																							

5 Relubrication option ^{2), 3)} in combination with motor mounting position, housing orientation, groove orientation	<table border="1"> <tr> <td>1</td> <td colspan="3">No additional relubrication hole (standard) (not with 3 o'clock motor mounting)</td> </tr> <tr> <td></td> <td>ETH032</td> <td>ETH050</td> <td>ETH080/ETH100/ETH125</td> </tr> <tr> <td></td> <td>A, B, C, D, G, J, K</td> <td>A, B, C, D, G, J, K</td> <td>A, C, E, G, J</td> </tr> <tr> <td>2</td> <td colspan="3">Relubricating hole in the profile 12 o'clock</td> </tr> <tr> <td></td> <td>ETH032</td> <td>ETH050</td> <td>ETH080/ETH100/ETH125</td> </tr> <tr> <td></td> <td>A, C, E, G, J</td> <td>B, D, K</td> <td>A, C, E, G, J</td> </tr> <tr> <td>3</td> <td colspan="3">Relubricating hole in the profile 3 o'clock</td> </tr> <tr> <td></td> <td>ETH032</td> <td>ETH050</td> <td>ETH080/ETH100/ETH125</td> </tr> <tr> <td></td> <td>B, D, K</td> <td>A, C, E, G, J</td> <td>A, C, E, G, J</td> </tr> <tr> <td>4</td> <td colspan="3">Relubricating hole in the profile 6 o'clock</td> </tr> <tr> <td></td> <td>ETH032</td> <td>ETH050</td> <td>ETH080/ETH100/ETH125</td> </tr> <tr> <td></td> <td>A, C, E, G, J</td> <td>B, D, K</td> <td>A, C, E, G, J</td> </tr> <tr> <td>5</td> <td colspan="3">Relubricating hole in the profile 9 o'clock</td> </tr> <tr> <td></td> <td>ETH032</td> <td>ETH050</td> <td>ETH080/ETH100/ETH125</td> </tr> <tr> <td></td> <td>B, D, K</td> <td>A, C, E, G, J</td> <td>A, C, E, G, J</td> </tr> </table>	1	No additional relubrication hole (standard) (not with 3 o'clock motor mounting)				ETH032	ETH050	ETH080/ETH100/ETH125		A, B, C, D, G, J, K	A, B, C, D, G, J, K	A, C, E, G, J	2	Relubricating hole in the profile 12 o'clock				ETH032	ETH050	ETH080/ETH100/ETH125		A, C, E, G, J	B, D, K	A, C, E, G, J	3	Relubricating hole in the profile 3 o'clock				ETH032	ETH050	ETH080/ETH100/ETH125		B, D, K	A, C, E, G, J	A, C, E, G, J	4	Relubricating hole in the profile 6 o'clock				ETH032	ETH050	ETH080/ETH100/ETH125		A, C, E, G, J	B, D, K	A, C, E, G, J	5	Relubricating hole in the profile 9 o'clock				ETH032	ETH050	ETH080/ETH100/ETH125		B, D, K	A, C, E, G, J	A, C, E, G, J
1	No additional relubrication hole (standard) (not with 3 o'clock motor mounting)																																																												
	ETH032	ETH050	ETH080/ETH100/ETH125																																																										
	A, B, C, D, G, J, K	A, B, C, D, G, J, K	A, C, E, G, J																																																										
2	Relubricating hole in the profile 12 o'clock																																																												
	ETH032	ETH050	ETH080/ETH100/ETH125																																																										
	A, C, E, G, J	B, D, K	A, C, E, G, J																																																										
3	Relubricating hole in the profile 3 o'clock																																																												
	ETH032	ETH050	ETH080/ETH100/ETH125																																																										
	B, D, K	A, C, E, G, J	A, C, E, G, J																																																										
4	Relubricating hole in the profile 6 o'clock																																																												
	ETH032	ETH050	ETH080/ETH100/ETH125																																																										
	A, C, E, G, J	B, D, K	A, C, E, G, J																																																										
5	Relubricating hole in the profile 9 o'clock																																																												
	ETH032	ETH050	ETH080/ETH100/ETH125																																																										
	B, D, K	A, C, E, G, J	A, C, E, G, J																																																										

6 Motor flange ⁴⁾
For ETH ATEX version use only ATEX certified motors/gearboxes (e.g. EX motor series)
ETH032/ETH050/ETH080: Motors always with key groove on the output shaft.
ETH100/ETH125: Motors always without key groove on the output shaft

	ETH032	ETH050	ETH080	ETH100	ETH125	
						With motor flange for Parker motor:
K1B	•	•				SMH60-B5/11, NX3 or EX3 (only for ETH032)
K1C	•	•				SMH82-B8/14
K1D		•	•			SMH82-B8/19, MH105-B9/19 (old HJ96 Motor), NX4 or EX4 (only for ETH050)
K1E		•	•			SMH82-B5/19, SMH100-B5/19, MH105-B5/19
K1F	•					SMH100-B5/14 ⁵⁾
K1J		•	•			SMH115-B7/24, MH105-B6/24, NX6 or EX6
K1K		•	•			SMH142-B5/24, MH145-B5/24
K1L			•	•		MH205-B5/38, SMH170-B5/38
K1M				•		MH265-B5/48
						With gearbox flange for Parker gearbox:
P1A	•	•				Pilot Ø50*11, PCD 70mm with Ø5,5mm fixing holes, shaft Ø16x40mm
P1B			•			Pilot Ø80*15, PCD 100mm with Ø6,5mm fixing holes, shaft Ø22x52mm
P1C				•	•	Pilot Ø110*16, PCD 130mm with Ø8,5mm fixing holes, shaft Ø32x68mm
P1D				•	•	Pilot Ø130*20, PCD 165mm with Ø11mm fixing holes, shaft Ø40x102mm
P1G	•	•				PE3
P1H		•				PE4
P1J			•			PE5
P1K				•		PE7
1xx						Special flange one-piece (customized)
2xx						Special flange two-piece (customized)
3xx						Cylinder inclusive overhung load adapter (customized) ETH032-080 & Parallel motor mount only

Additional motor mounting options on request.
Before mounting a motor not listed above, please consult the Parker support team at em-motion@parker.com.

7 Mounting type	
F	Thread on the cylinder body (standard) (ETH100, ETH125 does not have a mounting thread on the underside)
B	Foot mounting ^{6), 7)} (For ETH100, ETH125 only available in protection class option A)
C	Rear Clevis ⁶⁾
D	Centre trunnion mounting (not with motor mounting positions E, F, J, K), for lubricating option "1", the lubrication port is always in 6 o'clock position
G	Mounting Flanges ⁷⁾ (only with motor mounting positions A, B, C, D) (For ETH100, ETH125 only available in protection class option A)
J	Front plate ⁷⁾ (For ETH125 only available in protection class option A)
X	customized - please contact us
8 Thrust rod	
M	External thread (standard)
F	Internal Thread
K	Internal thread (for the reception of the force sensor with external thread) (only for ETH100, ETH125)
S	Spherical Rod Eye (stainless steel with protection class "B" and "C"; standard with protection class "A") (For ETH125 only available in protection class option A)
R	Parallel guiding with ball bushing ⁸⁾ (not with motor mounting positions E, F, J, K) (available only in protection class option A)
L	Alignment Coupler (available only in protection class option A)
X	customized - please contact us
9 Option	
N	Standard
A	Designation for ATEX Cylinder ^{8) 9)}

10 Stroke in mm				
	ETH032	ETH050	ETH080	ETH100/ ETH125
XXXX	50...1000	50...1200	100.1600	200...2000
customized in steps of 1 mm				
0100	Preferred Stroke Lengths (see page 54)			
0200				
0300				
0400				

11 Protection class	
A	IP54 with galvanized screws
B	IP 54 stainless version with VA screws
C	IP 65 like B + protective lacquer and specially sealed

12 Optional	
Uxx	Unique Version
Here, a number for customized cylinders is assigned, please contact us	
with ATEX Cylinders ⁹⁾	
000	Standard ATEX Cylinder
xxx	ATEX release xxx ATEX Applications-Identification No. xxx

- ETH080-ETH125 features 2 grooves each on all 4 sides (i.e. Code B=A or D=C, K=J), therefore codes A, C, E, G, J are possible for ETH080-ETH125.
- With parallel configuration, the motor may block access to the sensors and the lubrication port.
- Relubrication options 2-5:
The standard lubrication port is without function.
In case of actuators with very short strokes, the position of the lubrication port in the center of the profile may not be possible.
For more information see mounting instructions.
- Please check cylinder motor/gearbox combination with the aid of the table ("Motor Mounting Options" see page 23).
- Order Code SMH100-B5/14: " SMH100-...ET..." (the motor shaft diameter is replaced by the term "ET") (not in the motors catalog) only with feedback: Resolver, A7
- Not with motor mounting options A & B.
- Not for thrust rod R
- On request for ETH100, ETH125. Please observe the maximum permitted axial traction of the parallel guiding ("parallel guiding" see page 35)
- Please observe the explanations "ETH - Electro Thrust Cylinder for ATEX Environment" see page 12, "000" for ETH032/050/080, "xxx" for applications specific ATEX release, please contact us.

Software & Tools

- Actuator database
 - A special actuator database is available in the Compax3 ServoManager. You can simply enter the ETH type code for automatic controller parameterization.
- CAD-Configurator
 - Configure your electro cylinder CAD data online.
www.parker.com/eme/eth



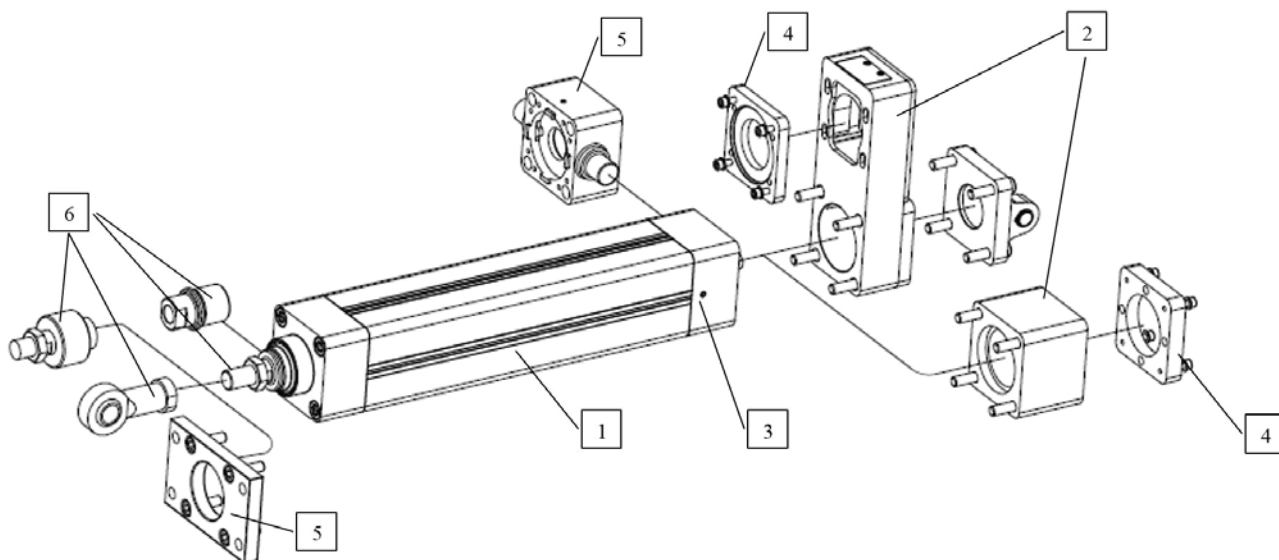

ETH032 Preferred cylinder order code with reduced lead time.

	1	2	3	4	5	6	7	8	9	10	11
	Size	Pitch	Motor orientation	Re-lubrication	Motor mounting	Cylinder mounting	Rod end	ATEX	Stroke	IP protection	
Example	ETH	032	M05	A	1	K1B	F	M	N	0200	A

									M05	M10	M16	
032	M05	A	1	K1B	F	M	N	0050				A
	M10	B	2	K1C	B	F	A	0100	0100	0100		B
	M16	C	3	K1D	C	K		0150				C
		D	4	K1E	D	S		0200	0200			
		E	5	K1F	G	R		0300	0300			
		G		K1J	J	L		0400	0400			
		J		K1K				others				
		K		K1L								
				K1M								
				P1A								
				P1B								
				P1C								
				P1D								
				P1G								
				P1H								
				P1J								
				P1K								

Black Options with reduced lead time. Only ETH cylinders with 100% of "black" options will be shipped within reduced lead time.

Grey Options with standard lead time. ETH cylinders including one or more "grey" options will be shipped within standard lead time.

Examples: **ETH032M05A1K1BFMN0200A** Reduced lead time (all options are "black")

ETH032M05A1K1BFRN0200A Standard lead time

ETH050 Preferred cylinder order code with reduced lead time.

	1	2	3	4	5	6	7	8	9	10	11
		Size	Pitch	Motor orientation	Re-lubrication	Motor mounting	Cylinder mounting	Rod end	ATEX	Stroke	IP protection
Example	ETH	050	M05	A	1	K1B	F	M	N	0100	A

										M05	M10	
050	M05	A	1	K1B	F	M	N			0050		A
	M10	B	2	K1C	B	F	A			0100	0100	B
		C	3	K1D	C	K				0150		C
		D	4	K1E	D	S				0200	0200	
		E	5	K1F	G	R					0250	
		G		K1J	J	L				0300	0300	
		J		K1K						0400	0400	
		K		K1L							0600	
				K1M						others		
				P1A								
				P1B								
				P1C								
				P1D								
				P1G								
				P1H								
				P1J								
				P1K								

Black Options with reduced lead time. Only ETH cylinders with 100% of "black" options will be shipped within reduced lead time.

Grey Options with standard lead time. ETH cylinders including one or more "grey" options will be shipped within standard lead time.

Examples: **ETH050M05A1K1BFMN0100A** Reduced lead time (all options are "black")

ETH050M05A1K1BFRN0100A Standard lead time

ETH080 Preferred cylinder order code with reduced lead time.

	1	2	3	4	5	6	7	8	9	10	11
		Size	Pitch	Motor orientation	Re-lubrication	Motor mounting	Cylinder mounting	Rod end	ATEX	Stroke	IP protection
Example	ETH	080	M05	A	1	K1E	F	M	N	0100	A

										M05	M10	
	080	M05	A	1	K1B	F	M	N		0100	0100	A
		M10	B	2	K1C	B	F	A		0150	0150	B
			C	3	K1D	C	K			0200	0200	C
			D	4	K1E	D	S			0300	0300	
			E	5	K1F	G	R				0350	
			G		K1J	J	L			0400	0400	
			J		K1K					0600		
			K		K1L						0700	
					K1M					others		
					P1A							
					P1B							
					P1C							
					P1D							
					P1G							
					P1H							
					P1J							
					P1K							

Black Options with reduced lead time. Only ETH cylinders with 100% of "black" options will be shipped within reduced lead time.

Grey Options with standard lead time. ETH cylinders including one or more "grey" options will be shipped within standard lead time.

Examples: **ETH080M05A1K1EFMN0100A** Reduced lead time (all options are "black")

ETH080M05A1K1EFRN0100A Standard lead time



Parker's Motion & Control Technologies

At Parker, we're guided by a relentless drive to help our customers become more productive and achieve higher levels of profitability by engineering the best systems for their requirements. It means looking at customer applications from many angles to find new ways to create value. Whatever the motion and control technology need, Parker has the experience, breadth of product and global reach to consistently deliver. No company knows more about motion and control technology than Parker. For further info call 00800 27 27 5374



Aerospace

Key Markets

Aftermarket services
Commercial transports
Engines
General & business aviation
Helicopters
Launch vehicles
Military aircraft
Missiles
Power generation
Regional transports
Unmanned aerial vehicles

Key Products

Control systems & actuation products
Engine systems & components
Fluid conveyance systems & components
Fluid metering, delivery & atomization devices
Fuel systems & components
Fuel tank inerting systems
Hydraulic systems & components
Thermal management
Wheels & brakes



Climate Control

Key Markets

Agriculture
Air conditioning
Construction Machinery
Food & beverage
Industrial machinery
Life sciences
Oil & gas
Precision cooling
Process
Refrigeration
Transportation

Key Products

Accumulators
Advanced actuators
CO₂ controls
Electronic controllers
Filter driers
Hand shut-off valves
Heat exchangers
Hose & fittings
Pressure regulating valves
Refrigerant distributors
Safety relief valves
Smart pumps
Solenoid valves
Thermostatic expansion valves



Electromechanical

Key Markets

Aerospace
Factory automation
Life science & medical
Machine tools
Packaging machinery
Paper machinery
Plastics machinery & converting
Primary metals
Semiconductor & electronics
Textile
Wire & cable

Key Products

AC/DC drives & systems
Electric actuators, gantry robots & slides
Electrohydraulic actuation systems
Electromechanical actuation systems
Human machine interface
Linear motors
Stepper motors, servo motors, drives & controls
Structural extrusions



Filtration

Key Markets

Aerospace
Food & beverage
Industrial plant & equipment
Life sciences
Marine
Mobile equipment
Oil & gas
Power generation & renewable energy
Process
Transportation
Water Purification

Key Products

Analytical gas generators
Compressed air filters & dryers
Engine air, coolant, fuel & oil filtration systems
Fluid condition monitoring systems
Hydraulic & lubrication filters
Hydrogen, nitrogen & zero air generators
Instrumentation filters
Membrane & fiber filters
Microfiltration
Sterile air filtration
Water desalination & purification filters & systems



Fluid & Gas Handling

Key Markets

Aerial lift
Agriculture
Bulk chemical handling
Construction machinery
Food & beverage
Fuel & gas delivery
Industrial machinery
Life sciences
Marine
Mining
Mobile
Oil & gas
Renewable energy
Transportation

Key Products

Check valves
Connectors for low pressure fluid conveyance
Deep sea umbilicals
Diagnostic equipment
Hose couplings
Industrial hose
Mooring systems & power cables
PTFE hose & tubing
Quick couplings
Rubber & thermoplastic hose
Tube fittings & adapters
Tubing & plastic fittings



Hydraulics

Key Markets

Aerial lift
Agriculture
Alternative energy
Construction machinery
Forestry
Industrial machinery
Machine tools
Marine
Material handling
Mining
Oil & gas
Power generation
Refuse vehicles
Renewable energy
Truck hydraulics
Turf equipment

Key Products

Accumulators
Cartridge valves
Electrohydraulic actuators
Human machine interfaces
Hybrid drives
Hydraulic cylinders
Hydraulic motors & pumps
Hydraulic systems
Hydraulic valves & controls
Hydrostatic steering
Integrated hydraulic circuits
Power take-offs
Power units
Rotary actuators
Sensors



Pneumatics

Key Markets

Aerospace
Conveyor & material handling
Factory automation
Life science & medical
Machine tools
Packaging machinery
Transportation & automotive

Key Products

Air preparation
Brass fittings & valves
Manifolds
Pneumatic accessories
Pneumatic actuators & grippers
Pneumatic valves & controls
Quick disconnects
Rotary actuators
Rubber & thermoplastic hose & couplings
Structural extrusions
Thermoplastic tubing & fittings
Vacuum generators, cups & sensors



Process Control

Key Markets

Alternative fuels
Biopharmaceuticals
Chemical & refining
Food & beverage
Marine & shipbuilding
Medical & dental
Microelectronics
Nuclear Power
Offshore oil exploration
Oil & gas
Pharmaceuticals
Power generation
Pulp & paper
Steel
Water/wastewater

Key Products

Analytical Instruments
Analytical sample conditioning products & systems
Chemical injection fittings & valves
Fluoropolymer chemical delivery fittings, valves & pumps
High purity gas delivery fittings, valves, regulators & digital flow controllers
Industrial mass flow meters/controllers
Permanent no-weld tube fittings
Precision industrial regulators & flow controllers
Process control double block & bleeds
Process control fittings, valves, regulators & manifold valves



Sealing & Shielding

Key Markets

Aerospace
Chemical processing
Consumer
Fluid power
General Industrial
Information technology
Life sciences
Microelectronics
Military
Oil & gas
Power generation
Renewable energy
Telecommunications
Transportation

Key Products

Dynamic seals
Elastomeric o-rings
Electro-medical instrument design & assembly
EMI shielding
Extruded & precision-cut, fabricated elastomeric seals
High temperature metal seals
Homogeneous & inserted elastomeric shapes
Medical device fabrication & assembly
Metal & plastic retained composite seals
Shielded optical windows
Silicone tubing & extrusions
Thermal management
Vibration dampening

Parker Worldwide

Europe, Middle East, Africa

AE – United Arab Emirates, Dubai
Tel: +971 4 8127100
parker.me@parker.com

AT – Austria, St. Florian
Tel: +43 (0)7224 66201
parker.austria@parker.com

AZ – Azerbaijan, Baku
Tel: +994 50 2233 458
parker.azerbaijan@parker.com

BE/NL/LU – Benelux, Hendrik Ido Ambacht
Tel: +31 (0)541 585 000
parker.nl@parker.com

BG – Bulgaria, Sofia
Tel: +359 2 980 1344
parker.bulgaria@parker.com

BY – Belarus, Minsk
Tel: +48 (0)22 573 24 00
parker.poland@parker.com

CH – Switzerland, Etoy
Tel: +41 (0)21 821 87 00
parker.switzerland@parker.com

CZ – Czech Republic, Klecany
Tel: +420 284 083 111
parker.czechrepublic@parker.com

DE – Germany, Kaarst
Tel: +49 (0)2131 4016 0
parker.germany@parker.com

DK – Denmark, Ballerup
Tel: +45 43 56 04 00
parker.denmark@parker.com

ES – Spain, Madrid
Tel: +34 902 330 001
parker.spain@parker.com

FI – Finland, Vantaa
Tel: +358 (0)20 753 2500
parker.finland@parker.com

FR – France, Contamine s/Arve
Tel: +33 (0)4 50 25 80 25
parker.france@parker.com

GR – Greece, Piraeus
Tel: +30 210 933 6450
parker.greece@parker.com

HU – Hungary, Budaörs
Tel: +36 23 885 470
parker.hungary@parker.com

IE – Ireland, Dublin
Tel: +353 (0)1 466 6370
parker.ireland@parker.com

IL – Israel
Tel: +39 02 45 19 21
parker.israel@parker.com

IT – Italy, Corsico (MI)
Tel: +39 02 45 19 21
parker.italy@parker.com

KZ – Kazakhstan, Almaty
Tel: +7 7273 561 000
parker.easteurope@parker.com

NO – Norway, Asker
Tel: +47 66 75 34 00
parker.norway@parker.com

PL – Poland, Warsaw
Tel: +48 (0)22 573 24 00
parker.poland@parker.com

PT – Portugal
Tel: +351 22 999 7360
parker.portugal@parker.com

RO – Romania, Bucharest
Tel: +40 21 252 1382
parker.romania@parker.com

RU – Russia, Moscow
Tel: +7 495 645-2156
parker.russia@parker.com

SE – Sweden, Borås
Tel: +46 (0)8 59 79 50 00
parker.sweden@parker.com

SK – Slovakia, Banská Bystrica
Tel: +421 484 162 252
parker.slovakia@parker.com

SL – Slovenia, Novo Mesto
Tel: +386 7 337 6650
parker.slovenia@parker.com

TR – Turkey, Istanbul
Tel: +90 216 4997081
parker.turkey@parker.com

UA – Ukraine, Kiev
Tel: +48 (0)22 573 24 00
parker.poland@parker.com

UK – United Kingdom, Warwick
Tel: +44 (0)1926 317 878
parker.uk@parker.com

ZA – South Africa, Kempton Park
Tel: +27 (0)11 961 0700
parker.southafrica@parker.com

North America

CA – Canada, Milton, Ontario
Tel: +1 905 693 3000

US – USA, Cleveland
Tel: +1 216 896 3000

Asia Pacific

AU – Australia, Castle Hill
Tel: +61 (0)2-9634 7777

CN – China, Shanghai
Tel: +86 21 2899 5000

HK – Hong Kong
Tel: +852 2428 8008

IN – India, Mumbai
Tel: +91 22 6513 7081-85

JP – Japan, Tokyo
Tel: +81 (0)3 6408 3901

KR – South Korea, Seoul
Tel: +82 2 559 0400

MY – Malaysia, Shah Alam
Tel: +60 3 7849 0800

NZ – New Zealand, Mt Wellington
Tel: +64 9 574 1744

SG – Singapore
Tel: +65 6887 6300

TH – Thailand, Bangkok
Tel: +662 186 7000

TW – Taiwan, Taipei
Tel: +886 2 2298 8987

South America

AR – Argentina, Buenos Aires
Tel: +54 3327 44 4129

BR – Brazil, Sao Jose dos Campos
Tel: +55 800 727 5374

CL – Chile, Santiago
Tel: +56 2 623 1216

MX – Mexico, Toluca
Tel: +52 72 2275 4200

EMEA Product Information Centre

Free phone: 00 800 27 27 5374

(from AT, BE, CH, CZ, DE, DK, EE, ES, FI, FR, IE, IL, IS, IT, LU, MT, NL, NO, PL, PT, RU, SE, SK, UK, ZA)

US Product Information Centre

Toll-free number: 1-800-27 27 537

www.parker.com

Your local authorized Parker distributor

